

Building stones for ecologically sound urban water management (from building level to urban planning level): some European examples.

Erik P.C. ROMBAUT, Master in Biology, Asst. Prof. Em.,
KULeuven faculteit Architectuur (Campus Sint-Lucas),
Hoogstraat 51, B-9000 Gent / Paleizenstraat 65-67, B-1030 Brussels.
Odisee TechnologieCampus Gent, Gbrs. de Smetstraat 1, B-9000 Gent.
+ 32 (0)3 7707147. erik.rombaut@scarlet.be

Structure of this presentation.

- **1. The cooling effect of the vegetation.**
 - 2. Some climatological backgrounds.
 - 3. Climate-proof architecture, city expansion and urban planning.
 - building level
 - district (city quarter) level
 - city level
-

Ecosystem services.

'The benefits people obtain from ecosystems'

Millennium Ecosystem Assessment (2005)

*'The contributions that ecosystems make to
human well-being'*

Common International Classification of
Ecosystem Services (CICES) (2013)

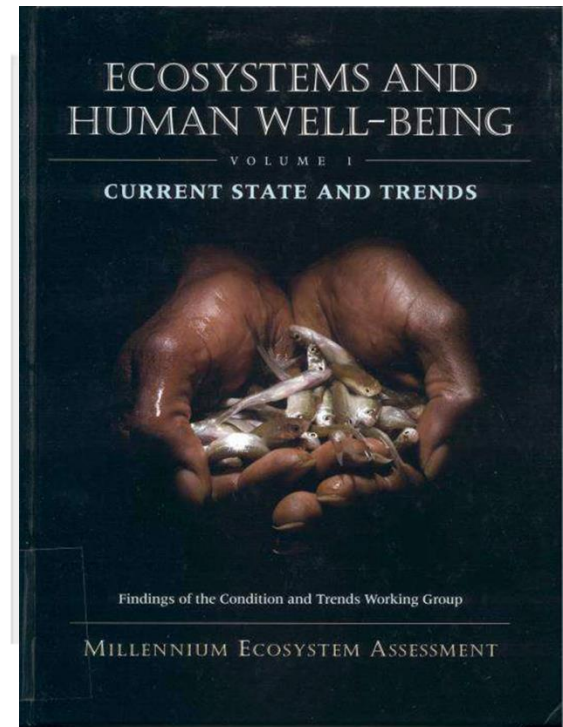

De voordelen die mensen verkrijgen van ecosystemen
(MEA, 2005)

De bijdragen van ecosystemen tot menselijk wel-bevinden
(CICES, 2013)

Ecosystem Services:

The set of services that 'nature' is offering to our society,
for free :

Producing and providing services:

*Food and fibres,
Fuel,
(Building)materials,
Fresh water,*

Regulating services:

*Carbon sequestration,
Climate regulation,
Erosion- and flood-control,
Water regulation and
-purification,
Disease control ,
Pollination, ...*

Cultural services:

*Inspiration,
Aesthetic, Spiritual,
Educational,
Recreation,
Health ,...*

Supporting services (necessary for services above)

Photosynthesis (C-cycling), Nutrient cycling (N, P, K, ...)

Water cycling, Biodiversity, Soil formation,....

One ecosystem service in detail: The cooling effect of vegetation.

Infrared spectrum

Visible spectrum

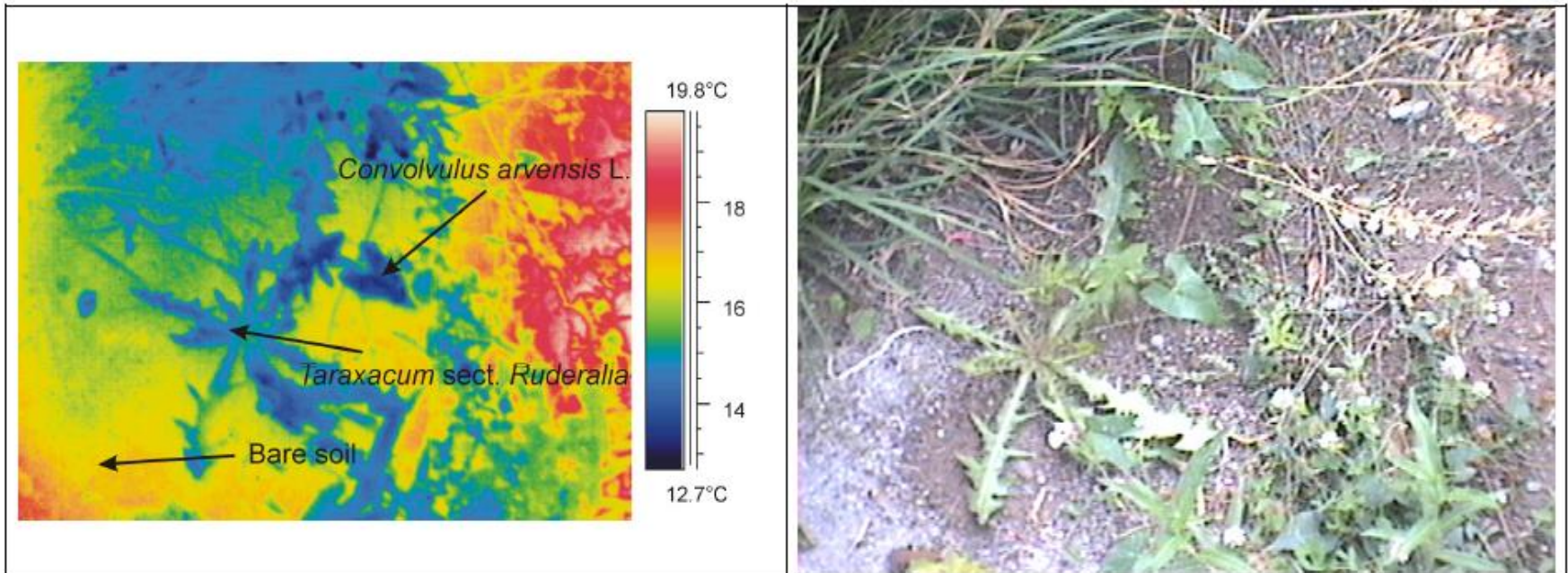

Fig. 7 Photographs of thin vegetation in the infrared spectrum and in the visible spectrum. The bare surface of the ground is visibly warmer than the surface of the leaves cooled by transpiration. (Třeboň, Czech Republic, 12 July 2002, 10:00 hrs).

The cooling effects of water evaporation and of transpiration through vegetation.

- **Evaporation** (1) includes *physical* vaporization from the soil and from plant surfaces.
 - **Transpiration** (2) (*biological*) is the water taken by the roots, transported through the plant and leaving through the stomata of the leaves (which can be opened and closed, regulating the amount of transpiration).
 - The total amount of involved water is **evapotranspiration** (1+2)
 - Because the vaporization of water needs a lot of latent heat, this system cools the local area down. The evaporation of 3 litres/m² of water needs 7,5 MJ /m².
-

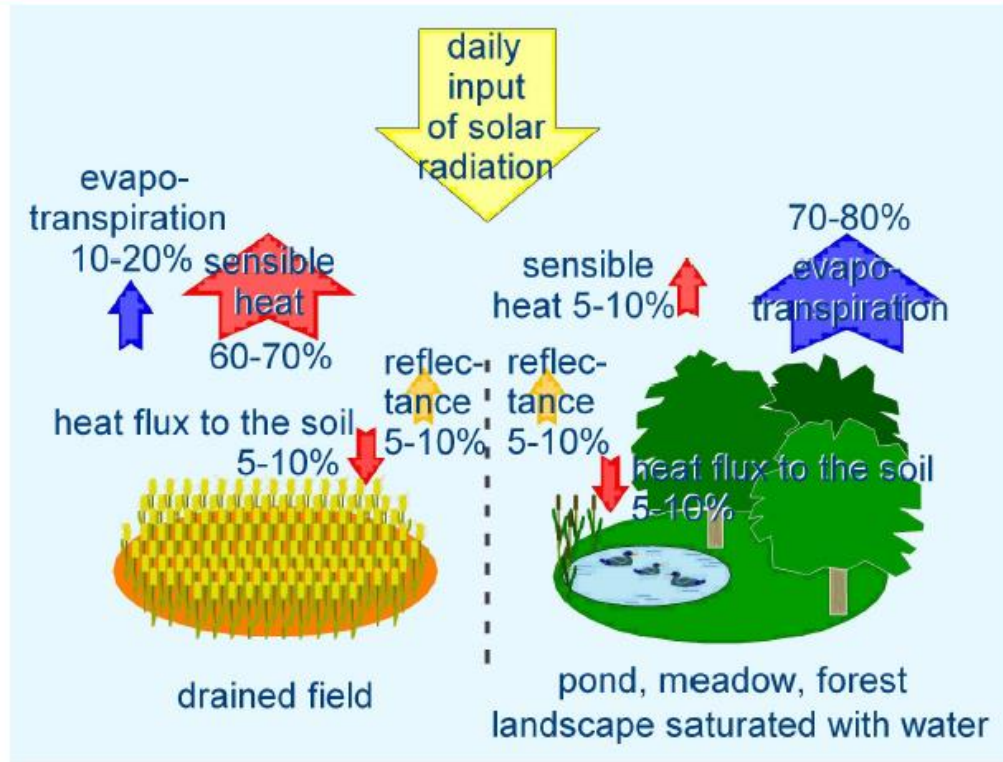

Fig. 4 The distribution of solar energy on drained land and on a landscape saturated with water

The input of solar energy is turned into sensible heat, in **drained landscapes** (left), which is leading to **higher local temperature**. **Wetlands** (right) turn solar energy into latent heat, taken away by evapotranspiration, and thus **lowering local temperature**.

Wetland landscapes remain cooler than dry landscapes
The presence of water as a local temperature regulator, in both urban and rural areas, is a very important ecosystem service.

As long as there is local water and moisture available (in rural but also in urban areas) the (summer) temperatures remain moderate and constant and do not exceed 30-35 °C (as in *(sub)tropical rainforests*). That is because locally evapotranspired water volumes do evacuate a lot of latent heat, which therefore is not turned into local sensible heat.

From the moment on water disappeared, temperatures will increase dramatically up to 50 °C and even more. This explains *desertification* as a consequence of drought, but it explains also the existence of the **urban heat island effect**.

The urban heat island effect.

<http://www.epa.gov/heatislands/resources/pdf/HIRIbrochure.pdf>

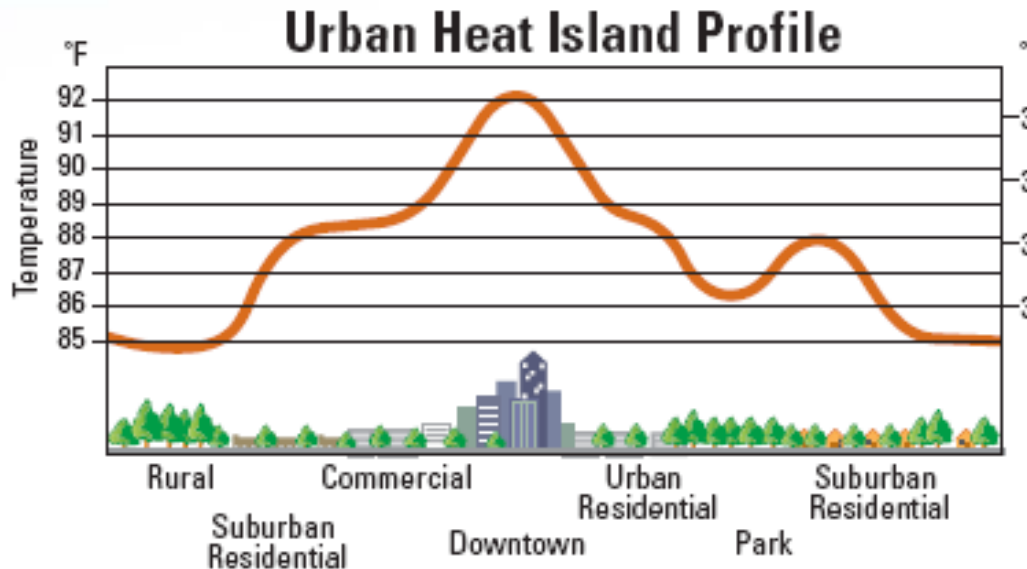

Heat islands are often largest over dense development but may be broken up by vegetated sections within an urban area.

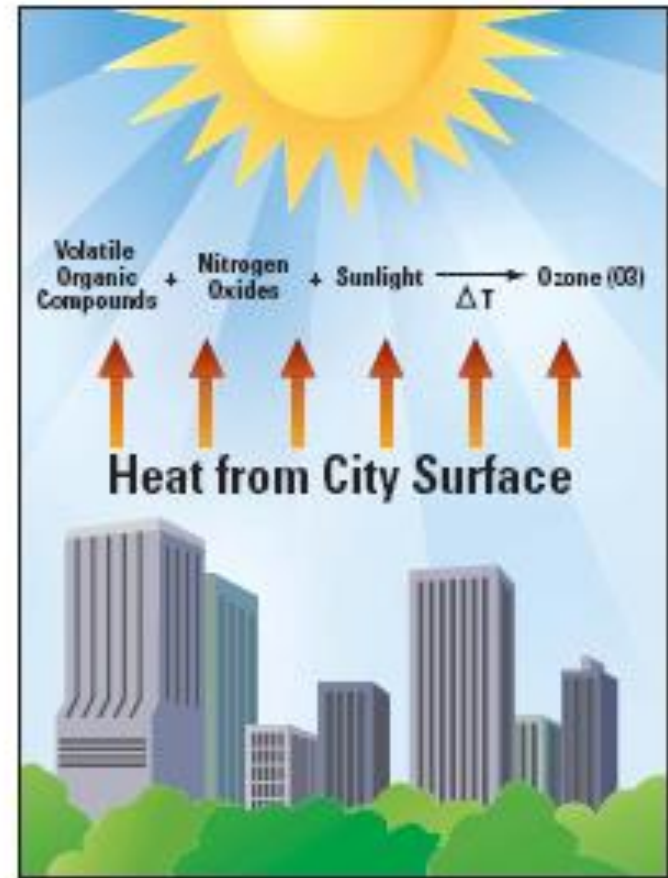

Ozone forms when precursor compounds react in the presence of sunlight and high temperatures.

This is the scientific background for understanding the occurrence of the urban heat island effect (UHI) in dry built-up environments, and for understanding the important role of blue-green fingers in urban areas (lobe-city), as huge 'cooling infrastructure'.

Stadtgröße City size

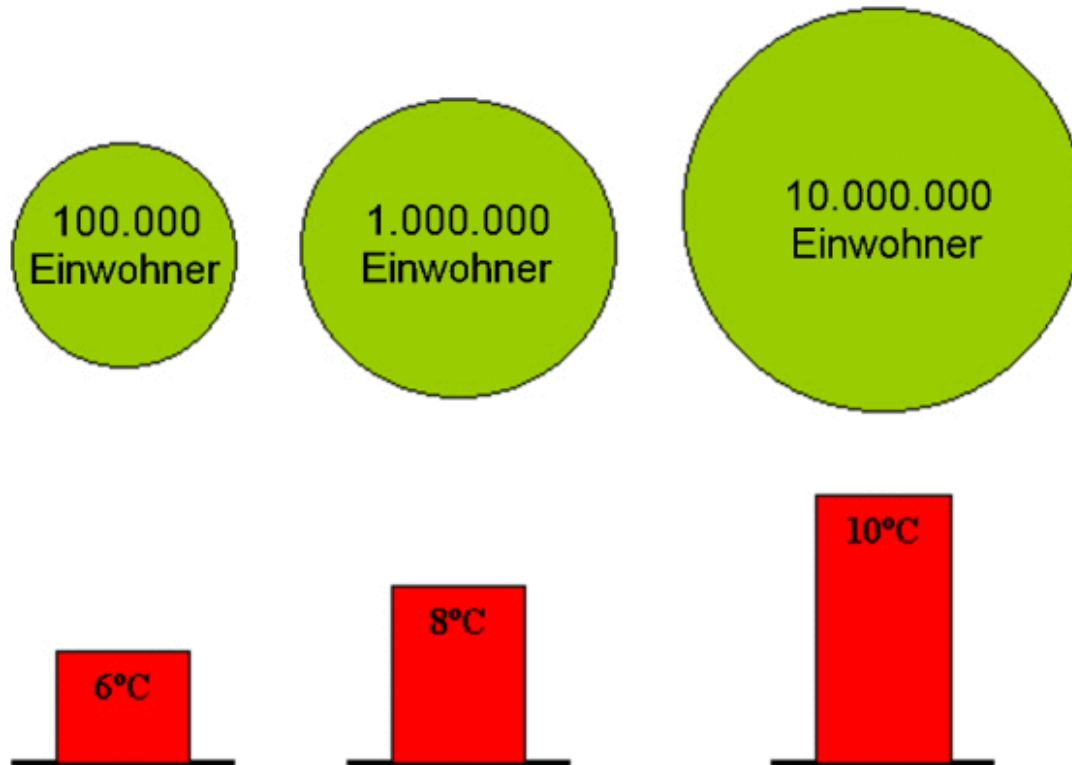

The amount of the urban heat island effect is depending on the number of citizens, on the size of the city.

Attention: This has little to do with temperature *averages* but deals with increasing *extremes*.

Grafik: Anita Bokwa,
Pawel Jezioro
(From S. Lippke, 2010)

Zunehmende maximale Temperaturdifferenz
zwischen Stadt und nicht-städtischer Umgebung
*Increasing maximum temperature difference
between urban and rural areas*

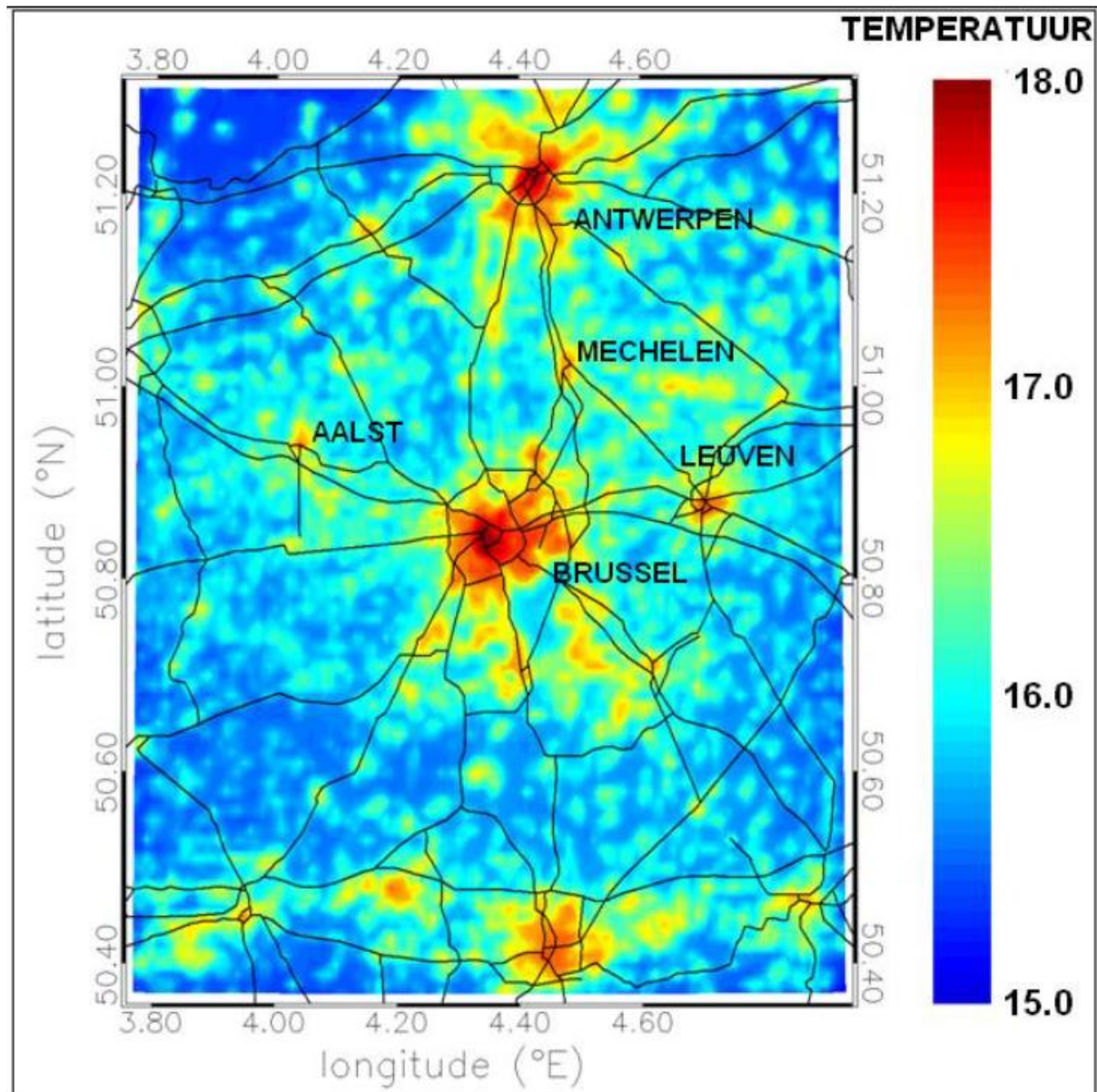

Figuur 3: Stedelijk hitte eiland effect in Vlaamse steden op basis van de gemiddelde temperatuur middernacht (00h00) in de periode mei-september 2008 (Bron: De Ridder et al., in prep.)

Some Asian examples

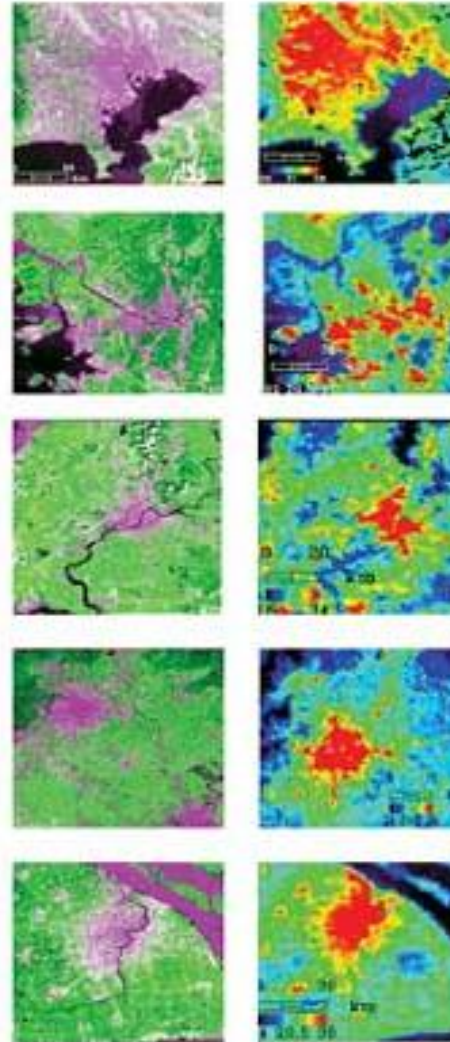
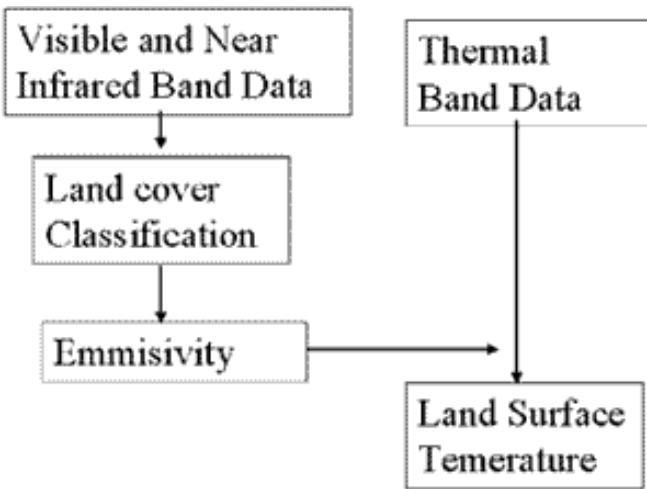

Fig-3 Visible band and thermal band for the study sites (Tokyo, Seoul, Pyongyang, Beijing and Shanghai, from top)

Shanghai (China) 1987



Source :Wollaert. 30/11/2015. Lecture Uantwerpen

<http://cifal-flanders.org/wp-content/uploads/2015/12/CIFAL-Flanders-Intro-Smart-Sustainable-Cities-Peter-Wollaert-30-11-2015.pdf>

Shanghai (China) 2012



Source :Wollaert. 30/11/2015. Lecture Uantwerpen

<http://cifal-flanders.org/wp-content/uploads/2015/12/CIFAL-Flanders-Intro-Smart-Sustainable-Cities-Peter-Wollaert-30-11-2015.pdf>

Structure of this presentation.

- 1. The cooling effect of the vegetation.
 - **2. Some climatological backgrounds.**
 - 3. Climate-proof architecture, city expansion and urban planning.
 - building level
 - district (city quarter) level
 - city level
-

The concept of the large and small watercycle.

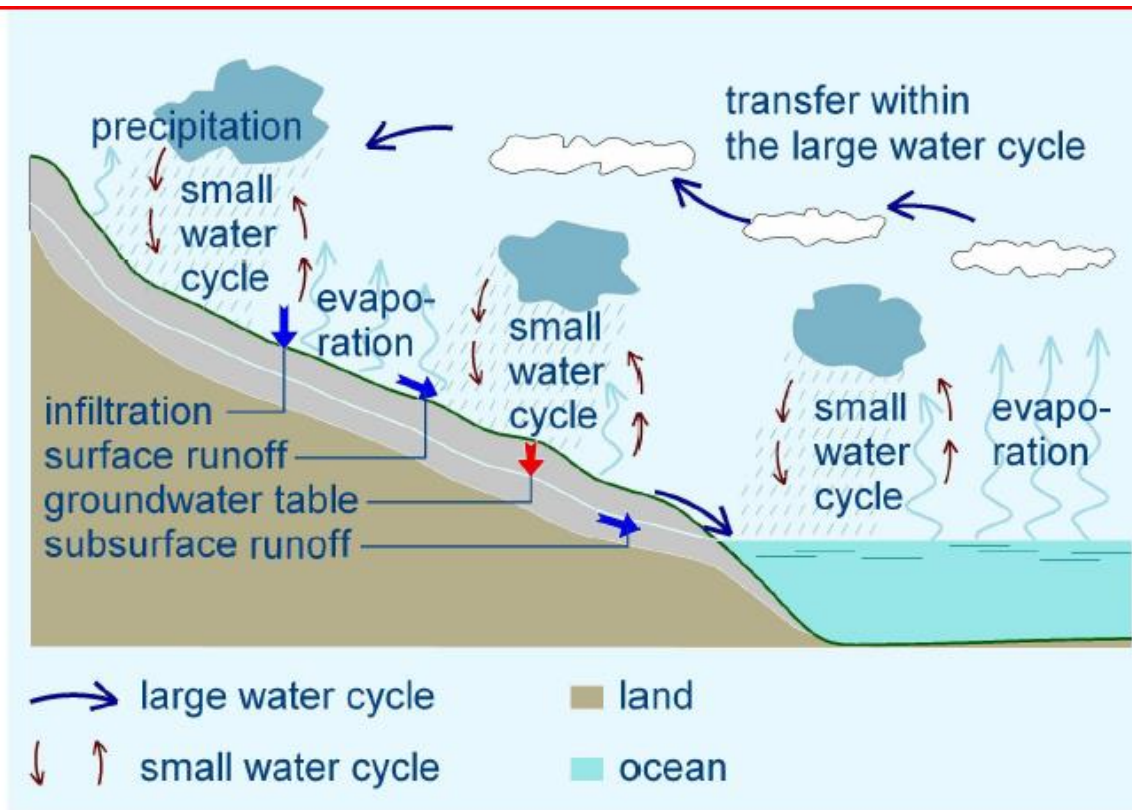
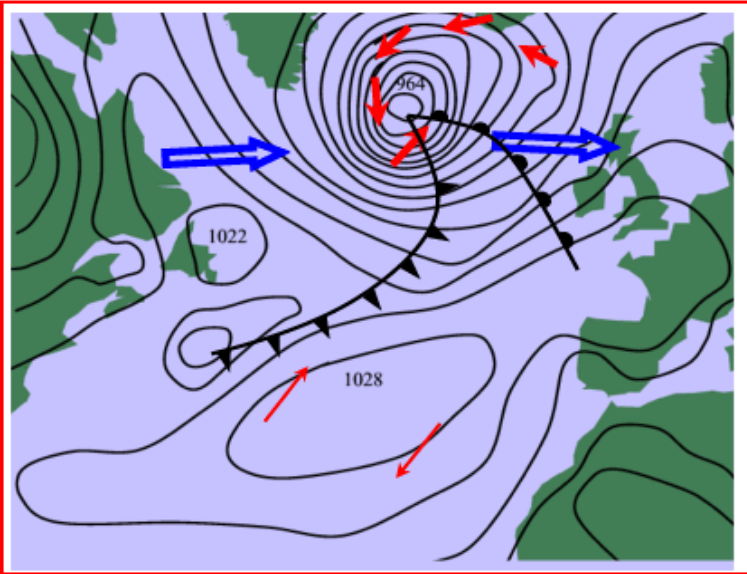

Fig. 1 The large and small water cycles on land

The large water cycle: exchange of water between oceans and land.

- 550.000 km³ of water evaporates / year into the atmosphere, 86 % from seas and oceans, 14 % from land.
- Atmospheric precipitation falls 74 % over the seas and 26 % over land.
- So there is a contribution from oceans, endowing the land with 12 % (86 % - 74 %) more water than is locally evaporated. This surplus is transported over a great distance above the land by clouds.

Depressions on the Atlantic ocean and North sea bring precipitation towards Europe (the large water cycle).



www.kayarchy.co.uk



Scotland: rain showers are coming on land, from the Atlantic ocean and the North Sea, carried by depressions.

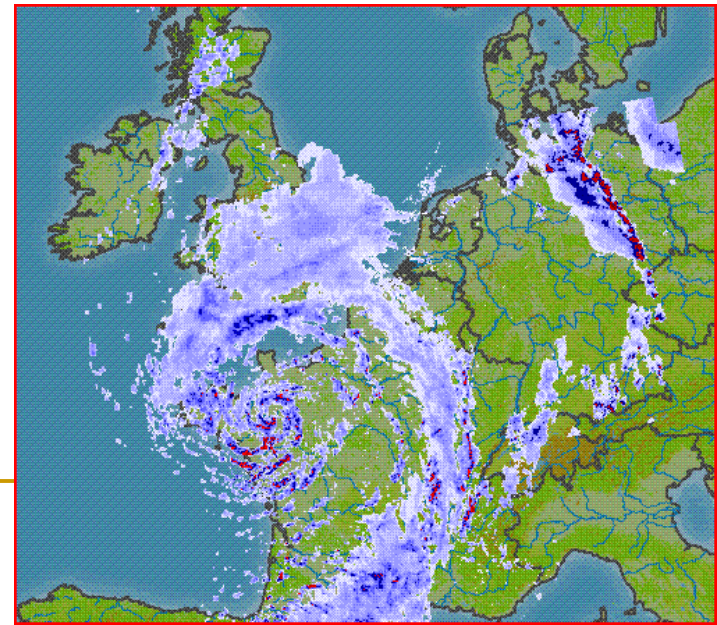

The concept of the large and small watercycles.

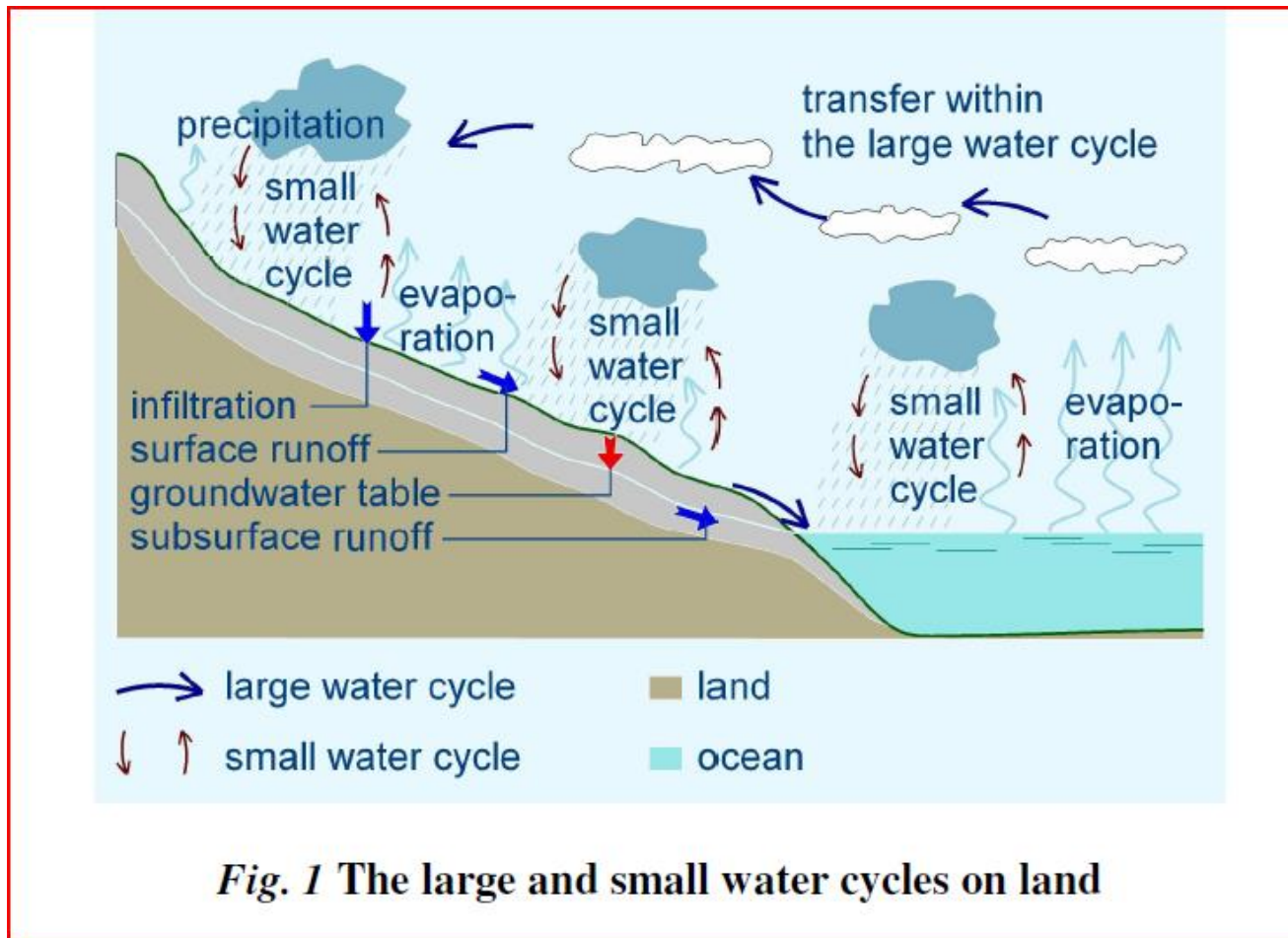

Fig. 1 The large and small water cycles on land

Forests, wetlands, especially moorland, are contributing very much to *local evapotranspiration*, and to *local small water cycles*, *cooling down local temperatures*, *increasing local air humidity* (fog).



www.natuurrondleidingen.nl



Moorlands in Finland.

The small water cycle: a closed circulation of *locally* evaporated and transpired water, which falls again as precipitation in the same region.

- Average rainfall in **Slovakia** is 720 mm/year. Input from oceans is 310 mm/year. Locally produced precipitation through small water cycles is 410 mm/year (!!). So the regional precipitation comes for more than 50 % from locally evapotranspired water.
 - So mankind cannot transform and drain the land limitlessly, without having a serious impact on its local precipitation: the volume of the small water cycle will gradually decrease. So a self-reinforcing phenomenon of further drying-out of the local environment is started: *more urbanisation and run-off, less evapotranspiration, less local rainfall, more drought and sensible heat, higher temperatures because the cooling effect of the evapotranspiration is decreasing....*
-

Contribution to the local water cycle, through the evaporation of a swimming pond.



Especially in dry urbanised regions it is important to restore the local contribution to the small water cycles, as is shown by this swimming pond example in which the local rain water is harvested from adjacent roofs, evaporating into the air.

A stable water cycle, over time.

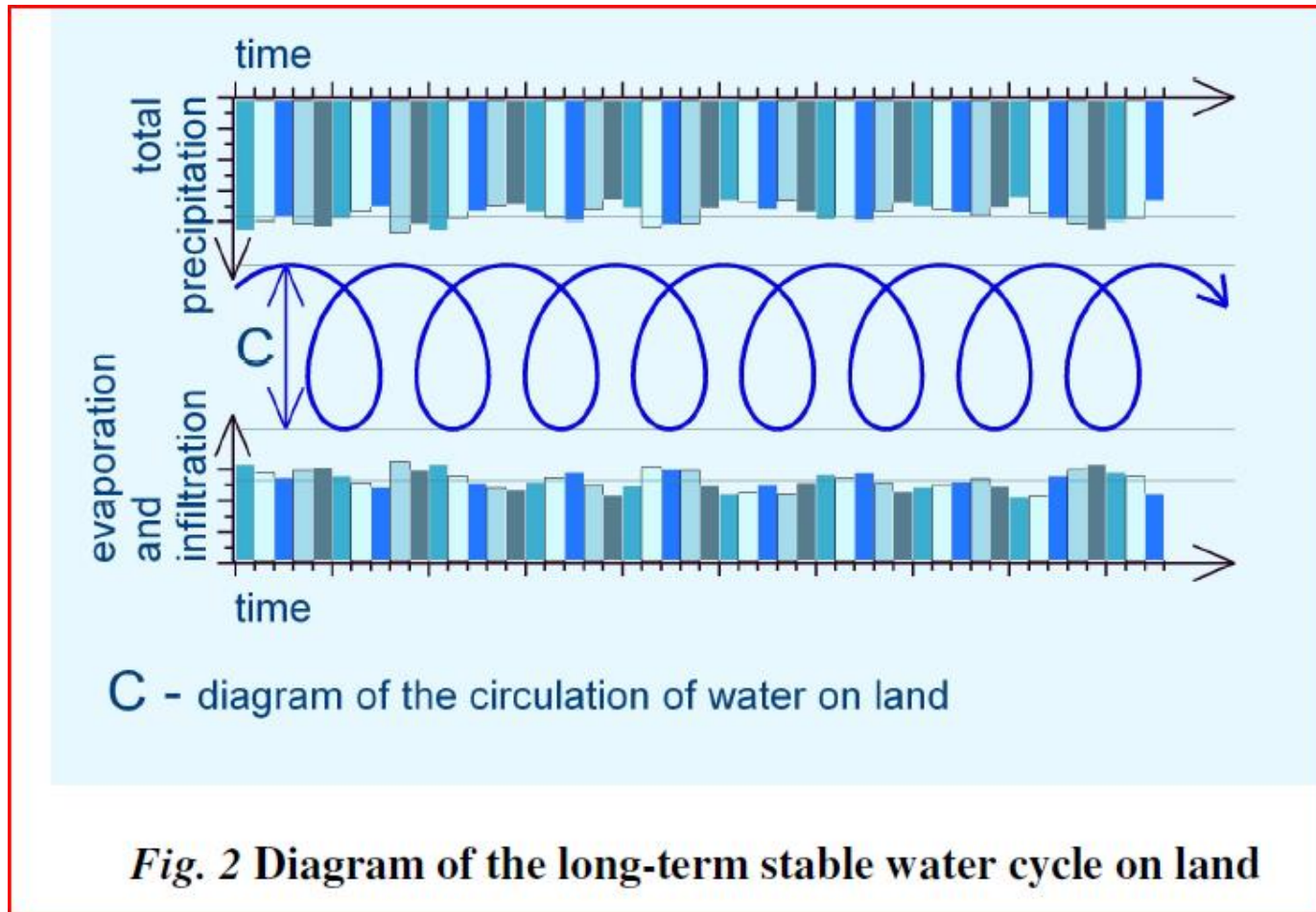

Stable local evapotranspiration over time, leads to stable small water cycles providing stable local precipitation.

Bad examples: non-permeable seal, disturbing local small water cycles, huge RUN-OFF.



Sint-Gillis Waas (B).

New parking areas for super markets Carrefour/GB en Aldi.

Additionally, these parking areas significantly contribute to the **urban heat island effect**,

Consequences of decreasing the small water cycle.

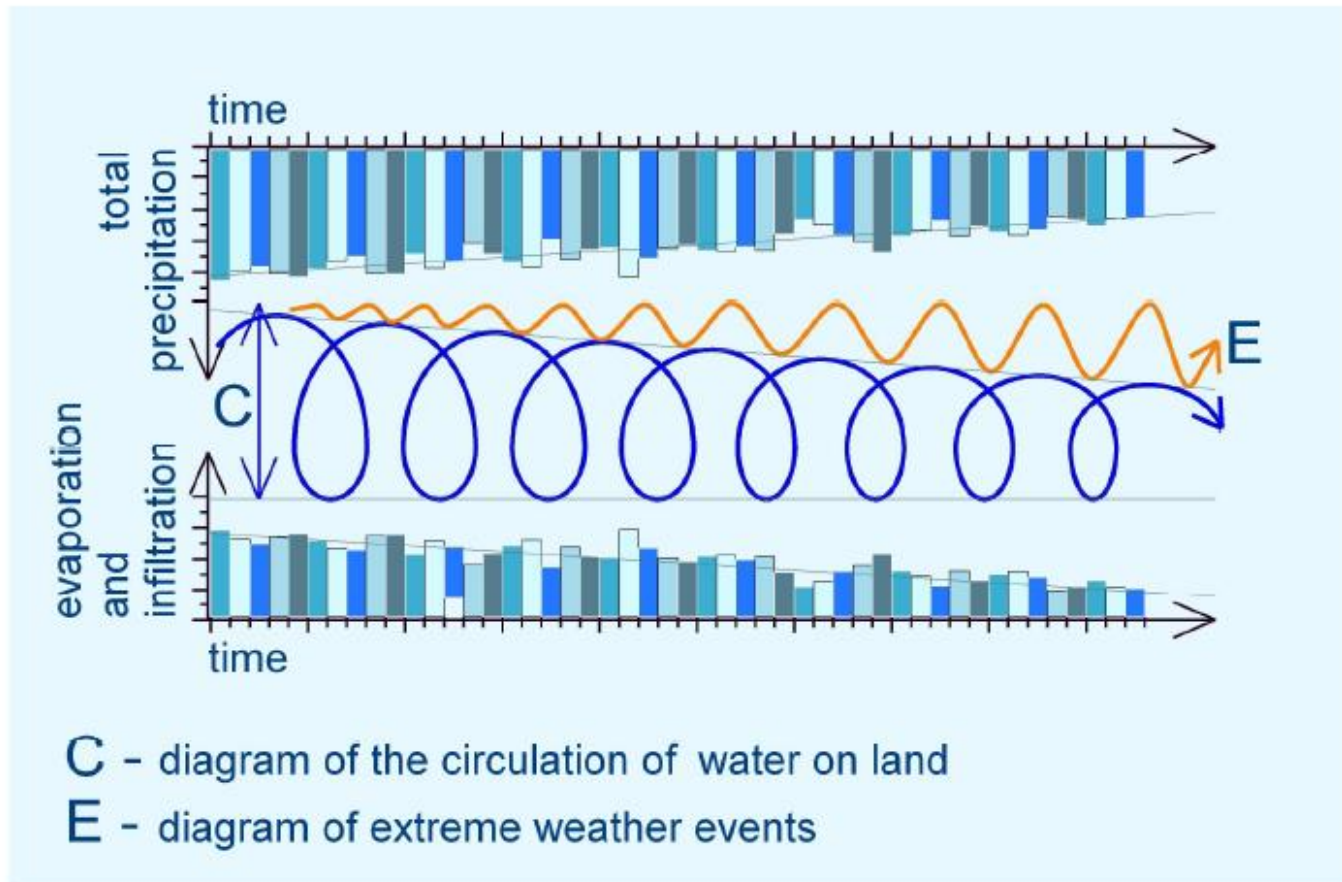

Fig. 17 The growth of extreme weather with the decrease of water in the small water cycle

Less evapotranspiration leads to decreasing locally generated rainfall and increasing risks **for extreme weather events,**

Slovakia, Tatra mountains. Situation 1800.

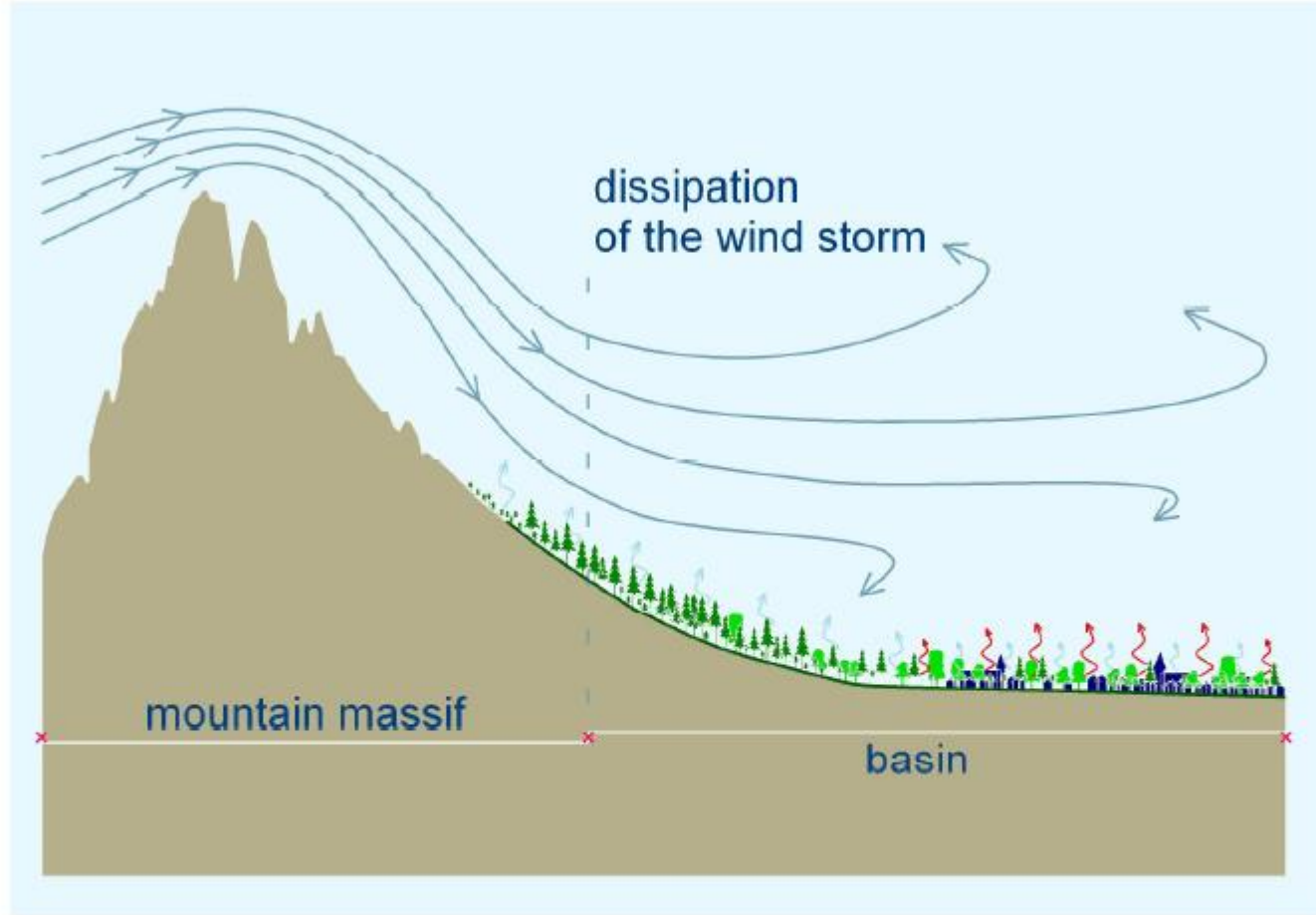

Fig. 24 The incursion of cold air to the High Tatras regions (the Tatra bora) - the assumed state around the year 1800

The conditions of the land under the mountains allowed for the gentle dissipation of the currents.

The destruction of the small water cycles by urbanisation and by draining for agricultural and forestry purposes.

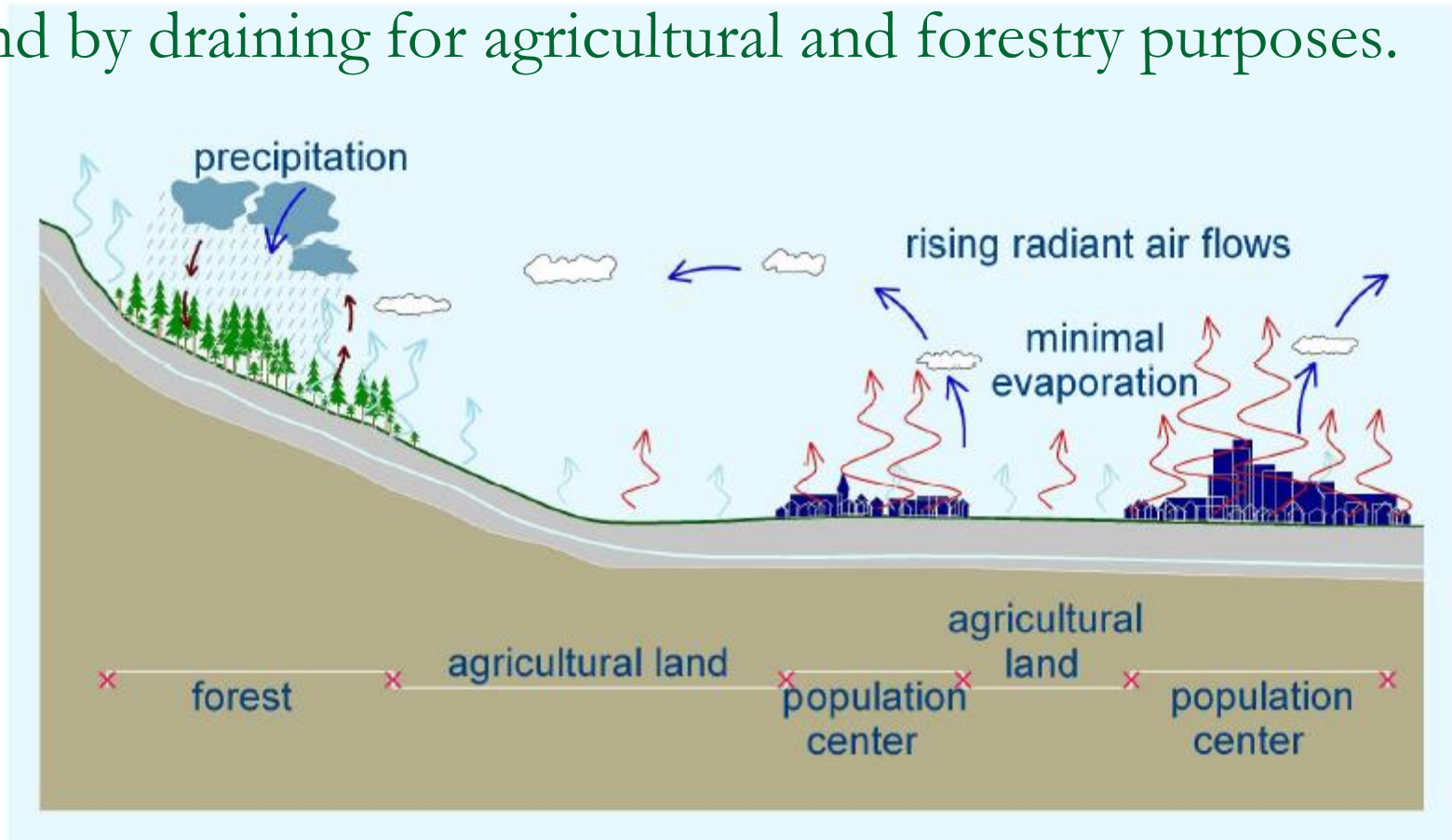

Fig. 18 The impact of the transformation of land on the destruction of small water cycles

Rising radiant flows push clouds to cooler environments.

Slovakia, Tatra mountains. Situation 2004.
Growing and increasing temperature contrasts thus:
Increasing risks for extreme weather events
See also flooding in **Balkan countries**
Spring 2014

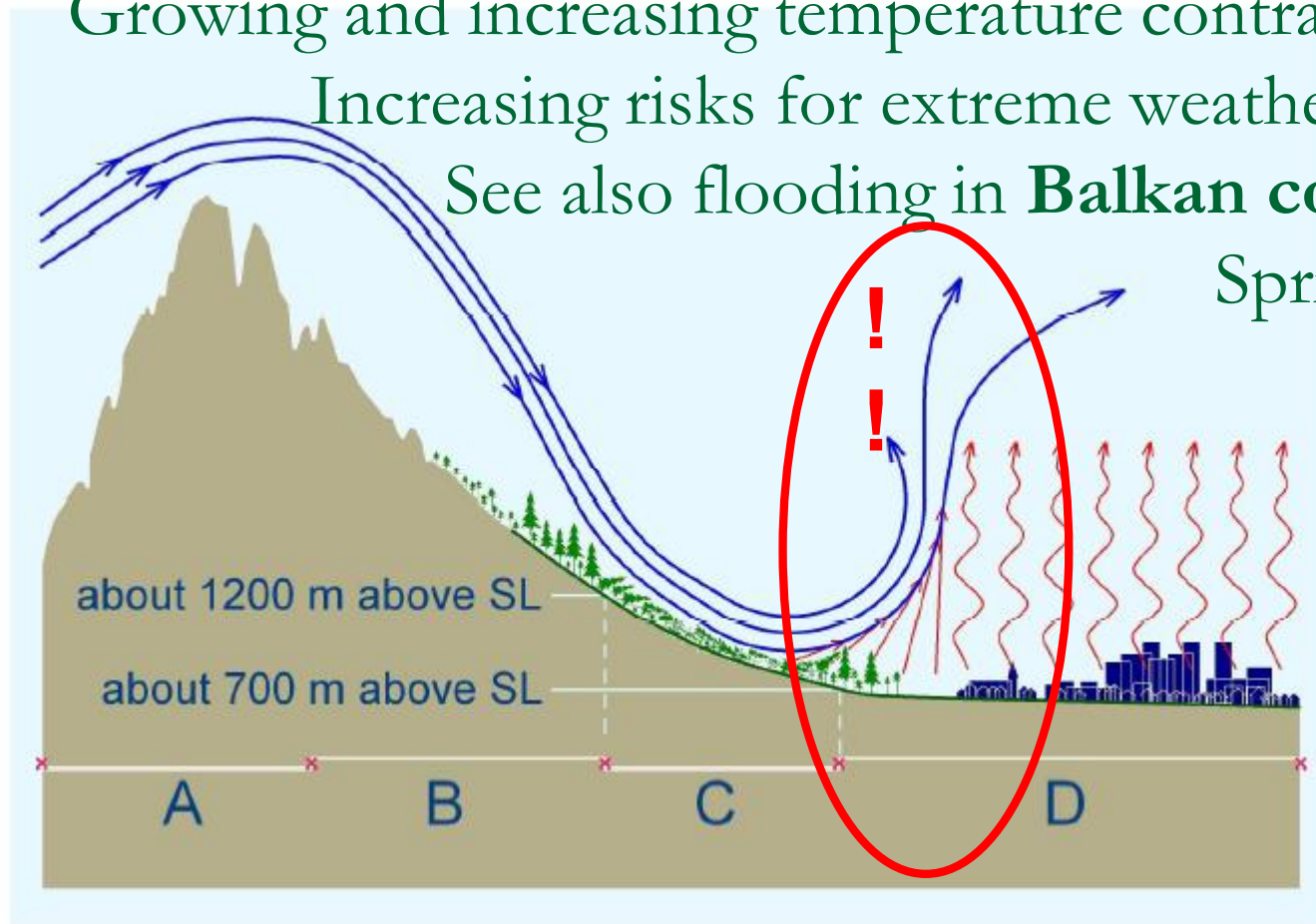

Fig. 25 Wind storm in the High Tatra mountains, Slovakia, November 19, 2004
Radiant flows of warmed currents from agricultural-urban areas (zone D) accelerated air currents with the rapidly falling cold front through the ridge of the High Tatra mountains:
 $v(A)$ 150 – 200 km/h, $v(B)$ < 100 km/h; $v(C)$ 200 – 250 km/h, $v(D)$ < 150 km/h.

So, Small water conservation measurements, such as here in the Tatra mountains (Slovakia) do matter, for *local climate* but are also *preventing flooding* downstream and *preventing erosion*



Fig. 35 A Water Forest in the High Tatras – building water conservation measures on territory destroyed by a natural disaster

An example of the renewal of vegetation and hydrological stabilization of a territory through the conservation of water on land.

Restoring the small urban and rural water cycles leads to local climate recovery and decreases risks for extreme weather events.

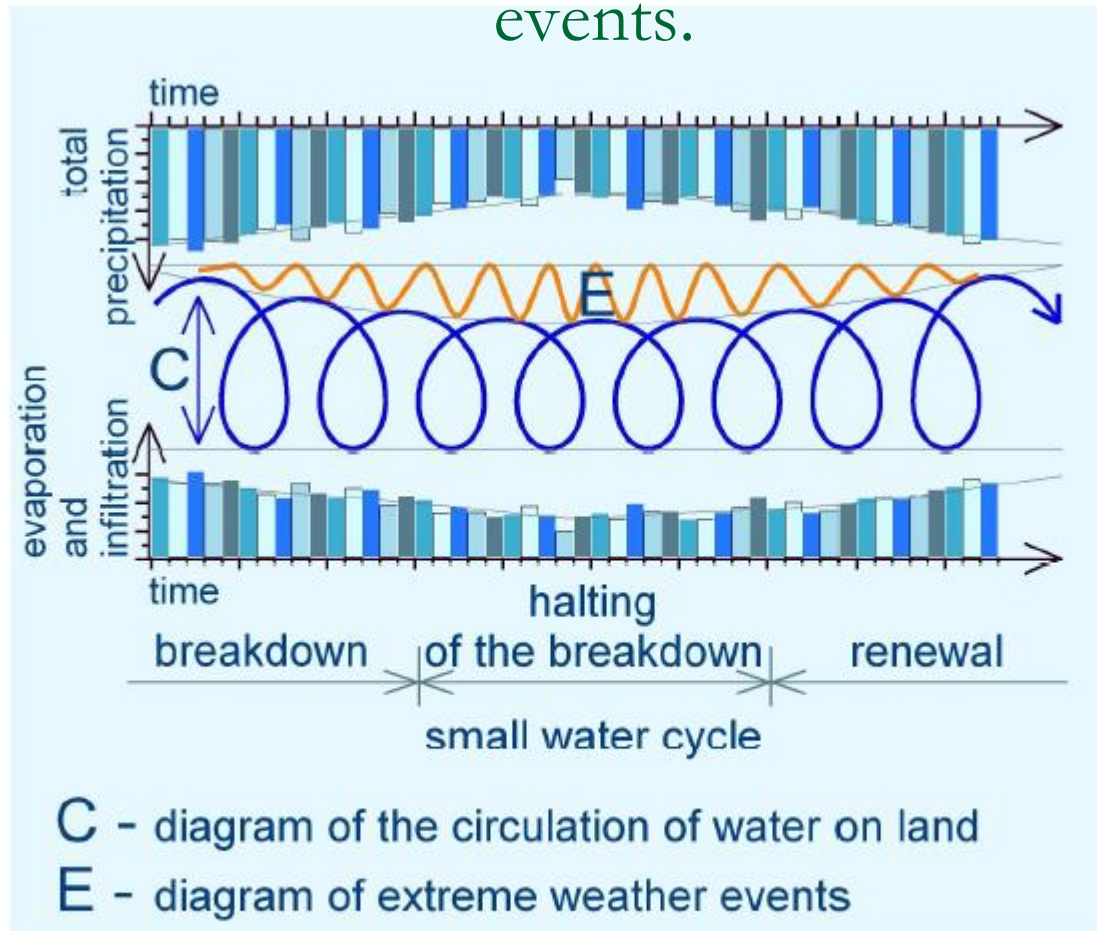
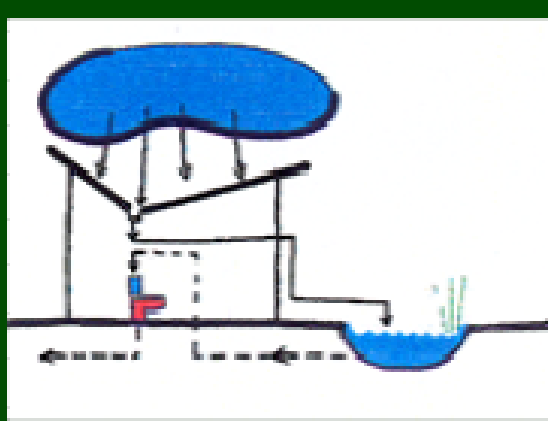

Fig. 27 The course of destruction of the small water cycle over land until it is halted and then renewed to its original state

Structure of this presentation.

- 1. The cooling effect of the vegetation.
 - 2. Some climatological backgrounds.
 - 3. Climate-proof architecture, city expansion and urban planning.
 - building level
 - district (city quarter) level
 - city level
-

The use of water as an organizing principle at different levels *in urban and rural environment is urgently needed.*



Building level

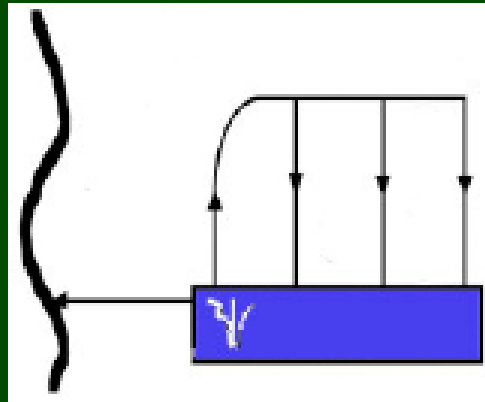

District level

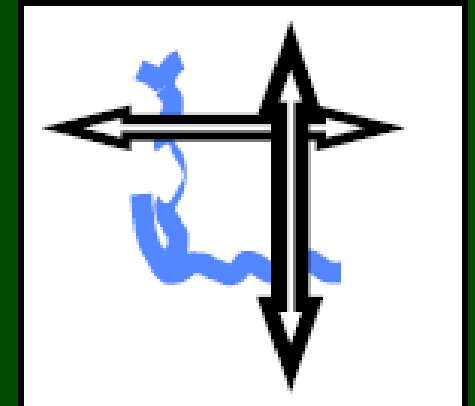

**City level and
rural areas**

= INTEGRAL WATER MANAGEMENT

Wise use of water on the building level

Wees wijs met water

**Drinkwater is om te drinken,
niet om de auto mee te wassen!**

Een waterbesparende douchekop en toilet raken steeds meer ingeburgerd, waardoor daadwerkelijk op drinkwater bespaard wordt.

Regenwater is prima te gebruiken voor het begieten van (kamer)planten. De opvang van regenwater in een vijver is een aanwinst voor de tuin.

In de piramide en het bezoekerscentrum wordt het doorspoelen van het toilet gedaan met regenwater. Een composttoilet, ook aanwezig in het bezoekerscentrum, kent zelfs helemaal geen waterspoeling of rioolaansluiting.



Toilets are wasting about 40 % of the drinking water in Belgium. Modern compost toilets don't.

Ecologically sound water management on the building level: using rainwater and saving systems.



TECHNISCHE GEGEVENS

GUSTAVSBERG

Water Saving System - WSS

GUSTAVSBERG

WSS
Water Saving System

STR

Increasing urban storm water run-off is raising flooding risks in rural areas downstream of the city

rural



A

urban



B



Grote nete 17 september 1998

Foto: aminal

Urbanisation is increasing storm water run-off.



Each m² sealed surface means (in Flanders) an obstacle for 800 litres (**80 buckets!!**) of rainwater /year.



Consequences: Hydrological research of the **Bellebeek** (Belgian inland brook), (Van der Beken, 1984, University Brussels)

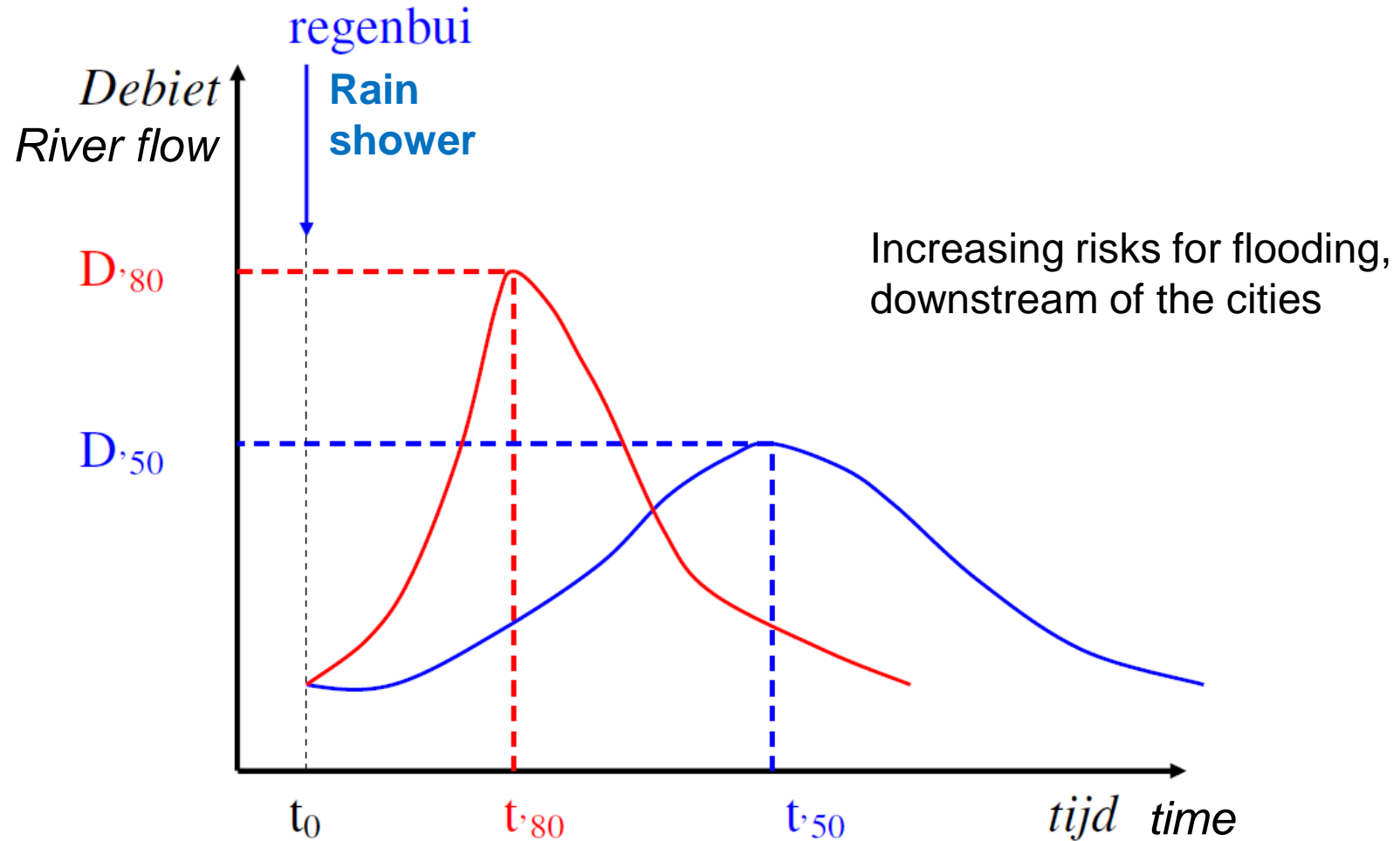

Current peak river flow rates from inland to the North Sea are **higher** and come **earlier** in the time after a rain shower, compared with the years 1950.

The same is the case all over Europe: example of the river **Rhine**, in the border region between France and Germany.

Source: Das Integrierte Rheinprogramm des Landes Baden-Württemberg (Hochwasserverschärfung)

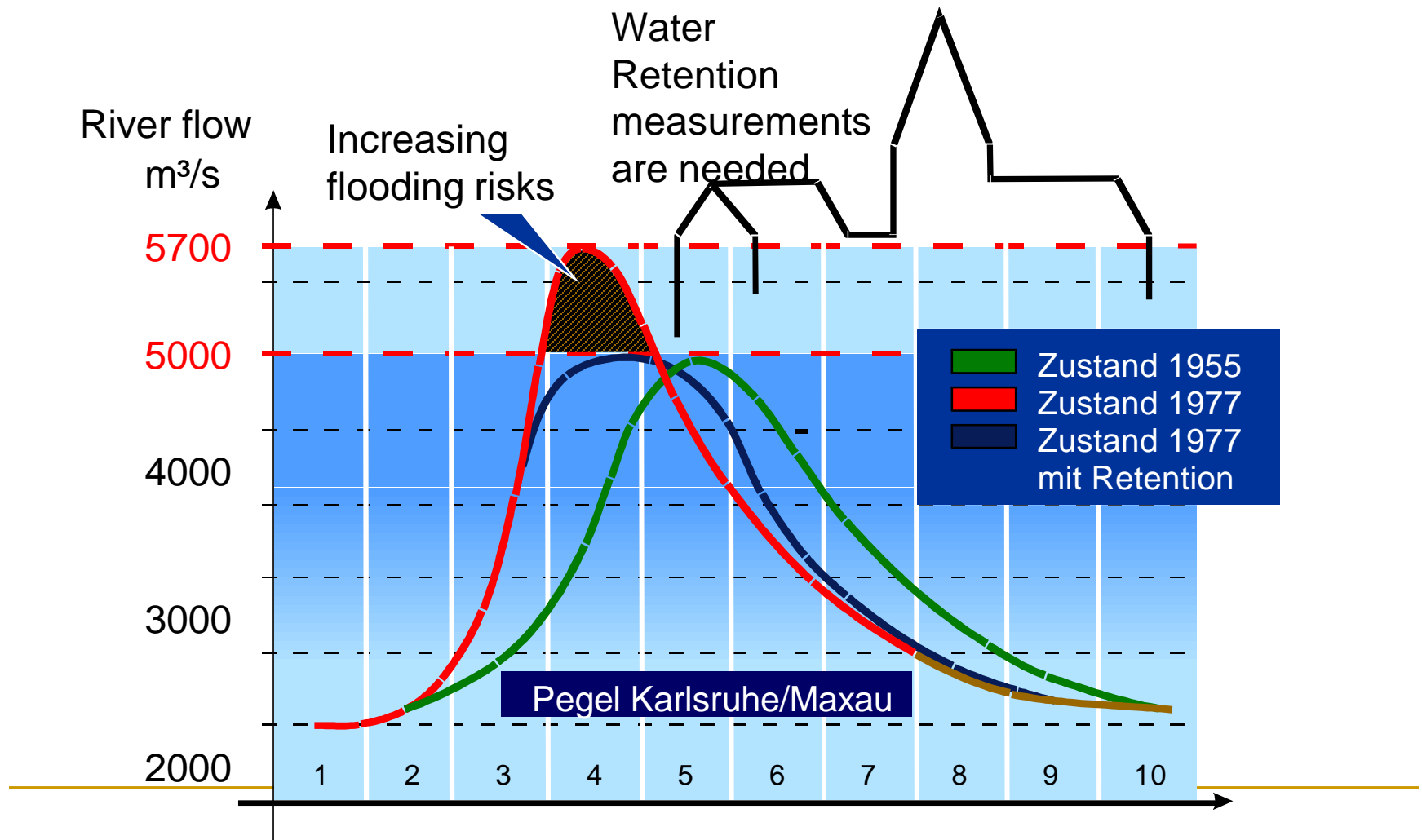

Good examples: permeable parkings.

Mechelen (B). Parking
Planckendael (Muizen)



Sint-Niklaas (B). Parking
Recreation area 'De Ster'.

Unsustainable use of water causes severe problems.

Mixing black, grey and white water in sewage systems causes capacity problems in the purification plants, in periods of heavy rainfall: **overflows** bring polluted water directly into the river.

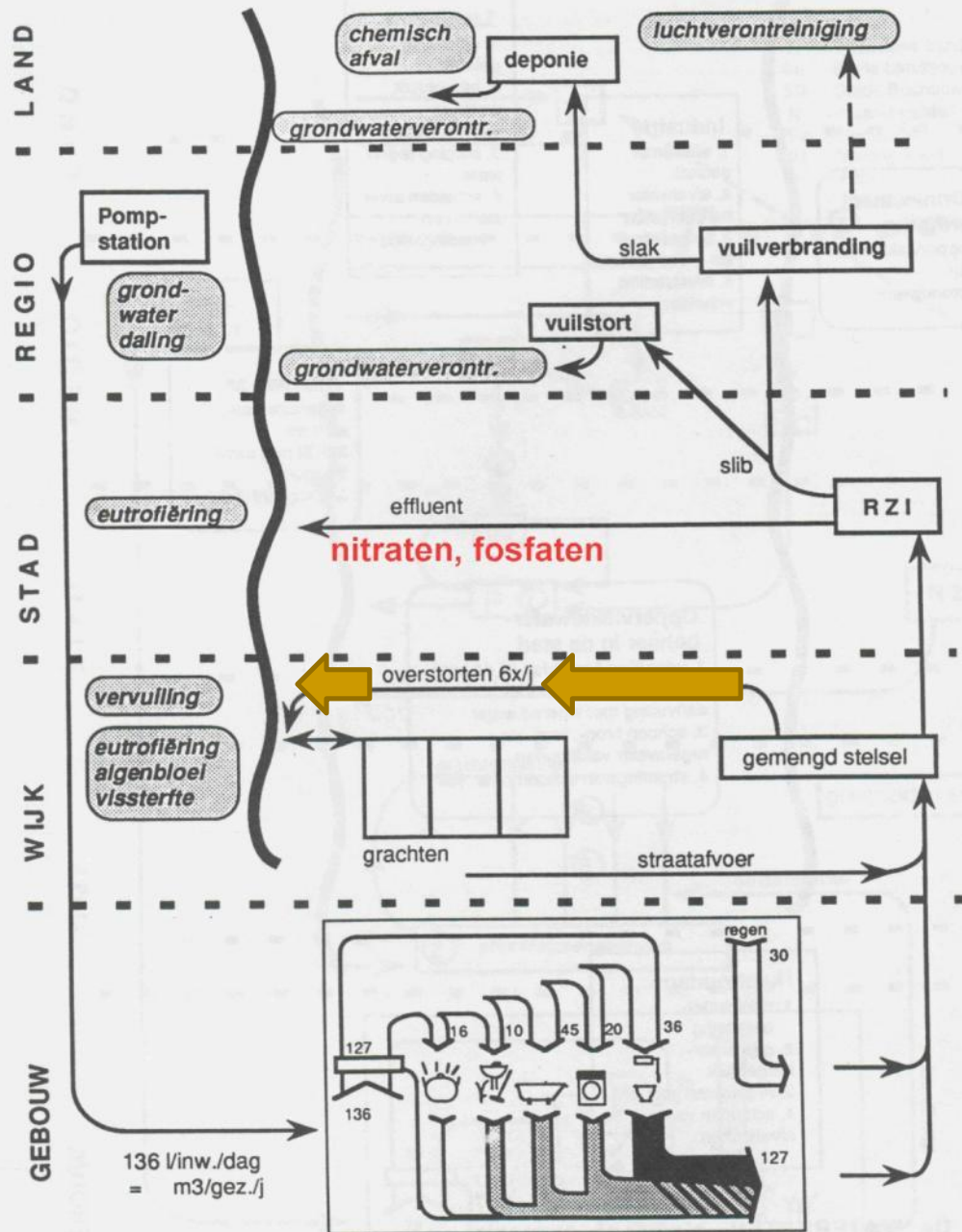

Figuur 2.3.1 De WATERKETEN, bestaande systemen en milieuproblemen.

Overflow is causing flooding



Dry weather conditions

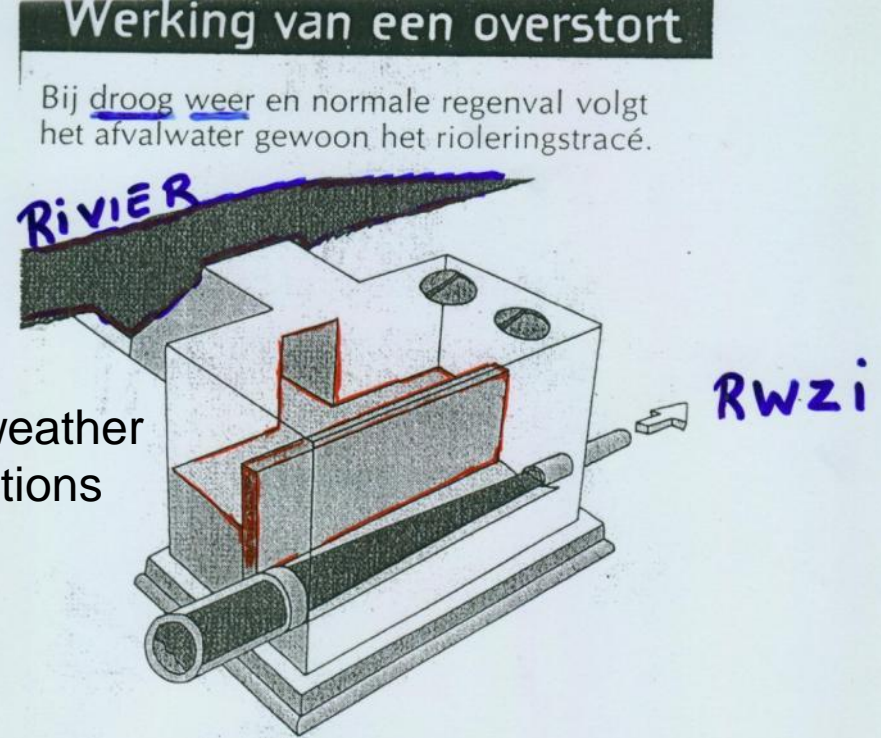

Bij aanhoudende regen zal het verdunde afvalwater over een muur stijgen en rechtstreeks naar de rivier stromen.

Wet weather conditions

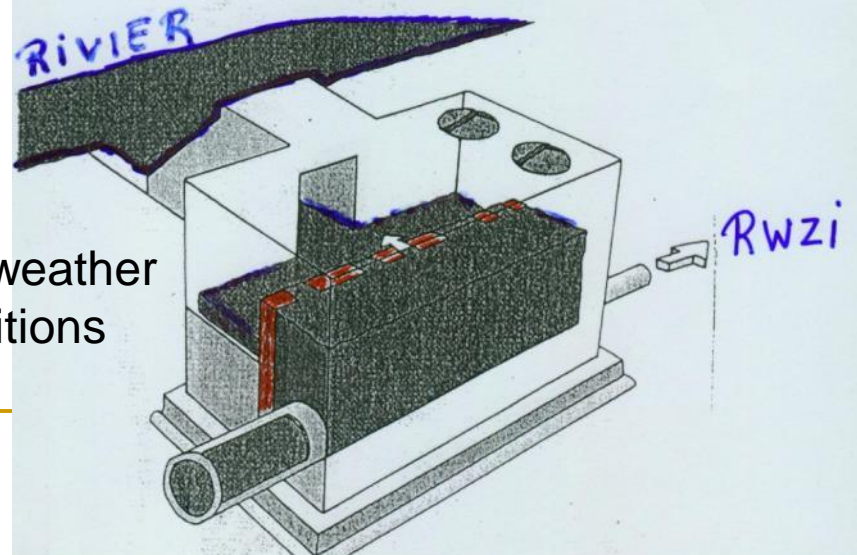

Disconnecting rainwater from roofs from the sewage system is necessary



Design water neutral:

Green roofs are minimising run-off amounts.





Eidfjord (N). Hardangervidda national park

Design not only carbon-neutral but also water-neutral: restore urban small water cycles

Boxtel (NL). De Kleine Aarde



Use succulent plants (such as *Sedum* sp.) for green roofs.
Green roofs are interesting for biodiversity, summer cooling and water management,....

Westerlo (B). Kamp C

Green facades and green roofs to support urban biodiversity and small urban water cycles.



Paris (F): Quai Branly



Paris (F) is planning minimum 100 ha green roofs and facades by 2020: <http://www.paris.fr/duvertpresdechezmoi>

Bosco Verticale, Milano (It)

SPONGE CITIES

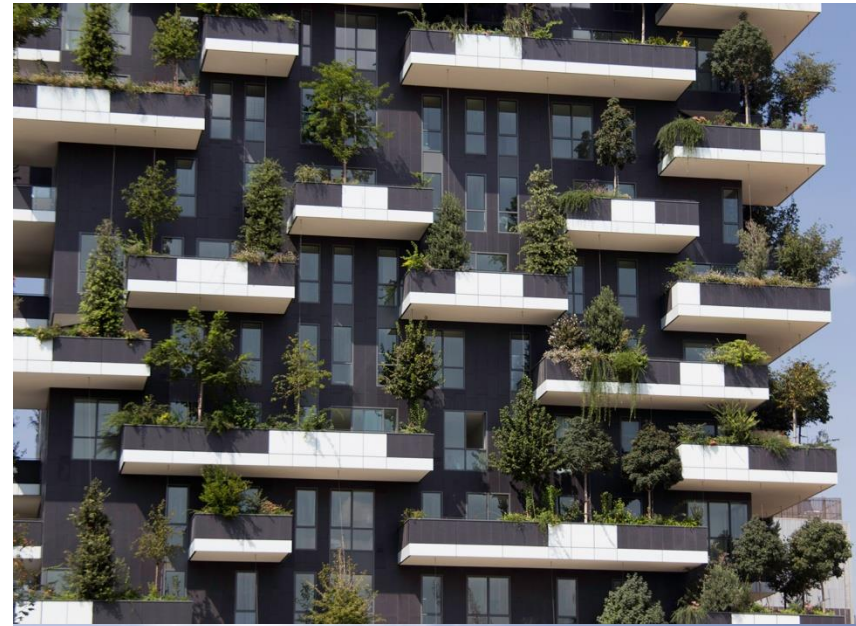

Bron: <http://thelandscape.org/2014/09/01/bosco-verticale-milan-the-next-step>
The landscape architects Emanuela Borio and Laura Gatti working with Stefano Boeri.
<https://cleantechnica.com/2017/12/04/berlin-reusing/> **SPONGE CITIES**



Hovden (N): water neutral ecoquarter.

Amsterdam (NL): designing with rainwater on the roof of the ING Bank.



Structure of this presentation.

- 1. The cooling effect of the vegetation.
 - 2. Some climatological backgrounds.
 - 3. Climate-proof architecture, city expansion and urban planning.
 - building level
 - district (city quarter) level
 - city level
-

Water management on city quarter level

- Separating sewage systems
 - Disconnecting rainwater from sewage
 - Collecting and re-using rain water
 - Infiltrating superabundant rainwater
- (figure from TJALLINGII, 1996)

Water en ruimtelijke ordening

Waterrijk Nederland kent wateroverlast en waterlekken. Door bebouwing, palibebouwing en grondwatergebruik dreigen delen van Nederland te verdrogen. Ook vanuit de bouw en ruimtelijke ordening kan dit probleem worden aangepakt.

Verdroging op het alland van Dordrecht



Een gezonde waterkringloop in het stedelijk gebied zorgt voor minder verdroging en dus voor een verhoging van de ruimtelijke kwaliteit van de leefomgeving.



Vasthouden regenwater en zuiveren water



Verbeterd gescheiden rioolstelsel
Huishoudelijk afvalwater wordt gescheiden van regenwater
Mena Park Dordrecht

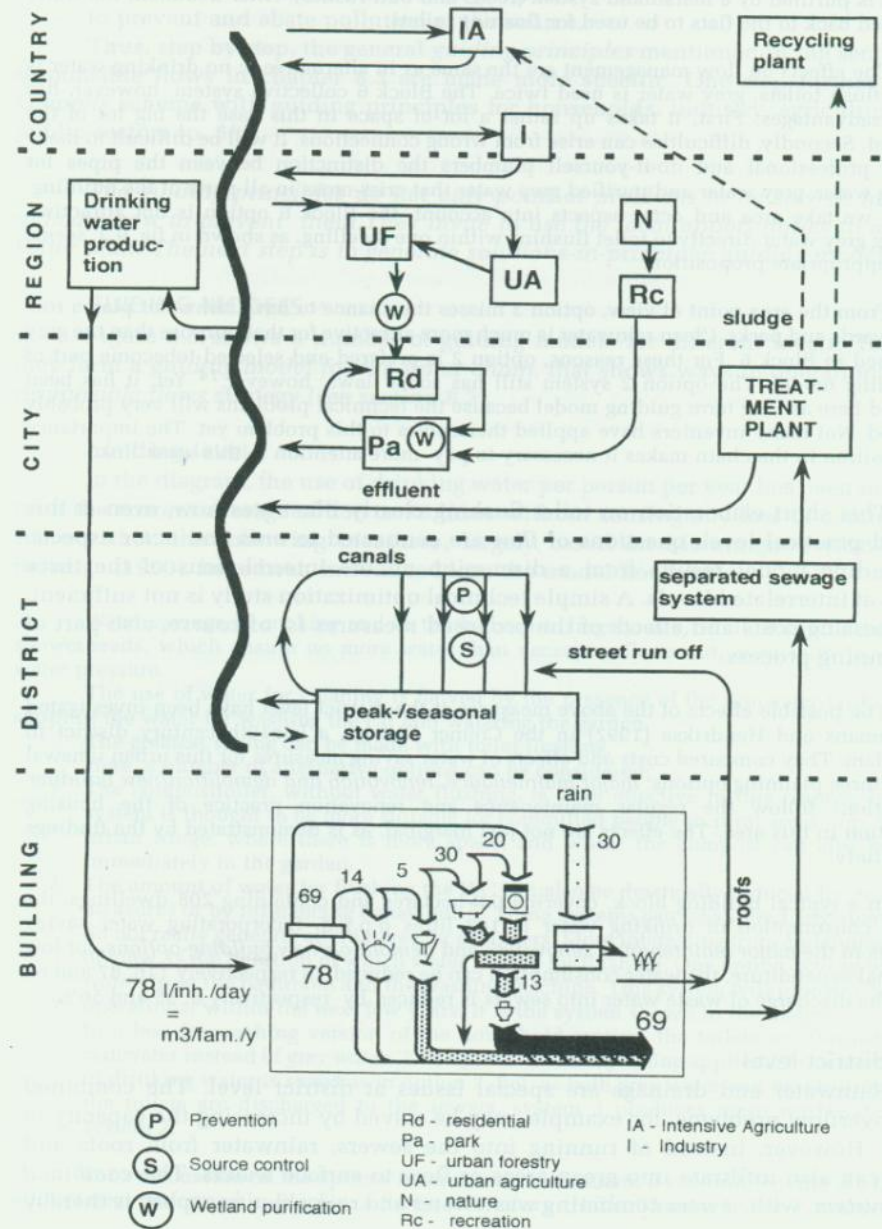

Figure 9.3:
Guiding models for the water chain (lowland situation).
source: Ecopolis.

Separate sewage systems
on city quarter level



Belfort Bethoncourt (F)

Culemborg (NL)

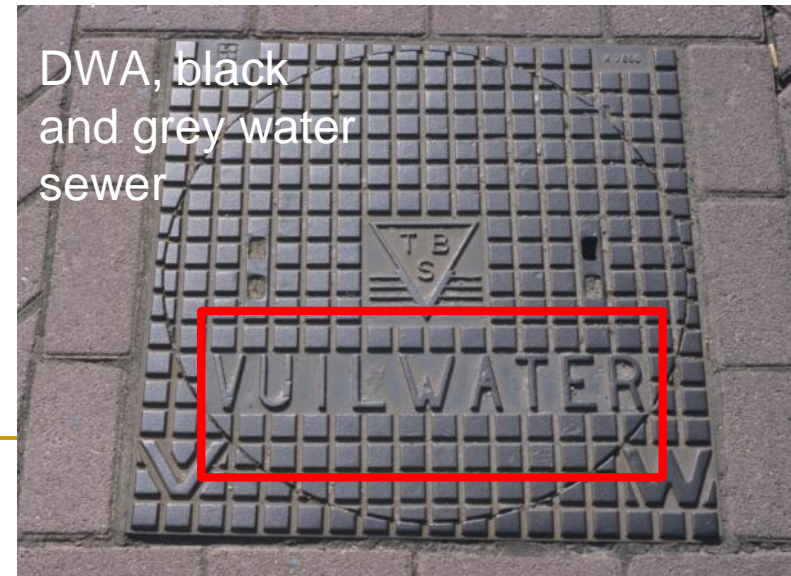

Alphen a/d Rijn (NL):
Ecoquarier *Ecolonia*.
Infiltration pond



Gesamt-
verrohrung

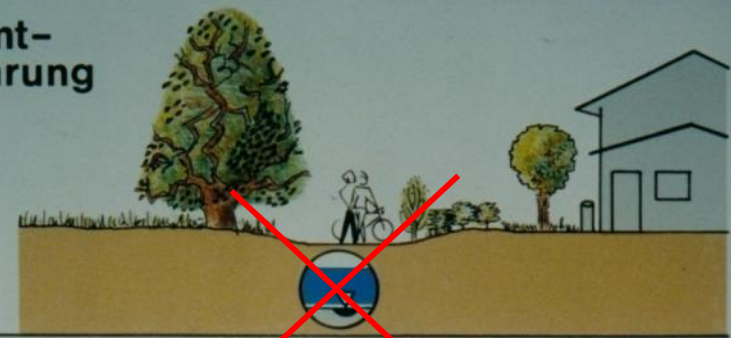

Kanal mit Flutmulde

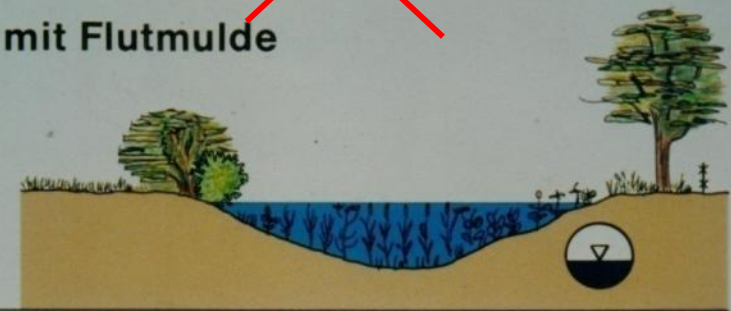

Stadtgewässer, Abfangsammler



Renaturiertes Gewässer,
Abfangsammler

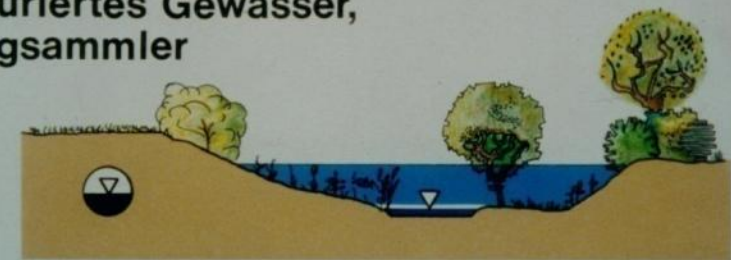

Möglichkeiten
der Umgestaltung von
Schmutzwasserläufen

1989
229/112

Infiltration zone in Gelsenkirchen (D).



Infiltration zone in the ecoquarter *Koppersbusch*.





Permeable
parking area

Gelsenkirchen (D) eco quarter *Schüngelberg*.



WADI technique.

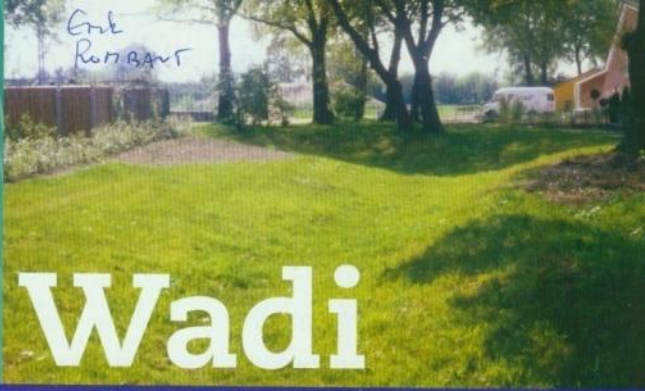

Een natuurlijke regulering van hemelwater



Werking van een wadi

- 1 Afvoer van het regenwater gaat niet onder de grond maar naar de regenot of via gootjes naar de weg of naar de wadi.
- 2 Straat is hol uitgevoerd, zonder straatkolken en loopt af naar de wadi.
- 3 De kruising met de wadi is tevens verkeersremmer.
- 4 Regenwater infiltreert. De bodem zuivert het water.
- 5 Sleuf met kleikorrels om het water te bufferen voordat het verder de grond intrekt.
- 6 Drainagebuis om de stand van het grondwater op peil te houden.

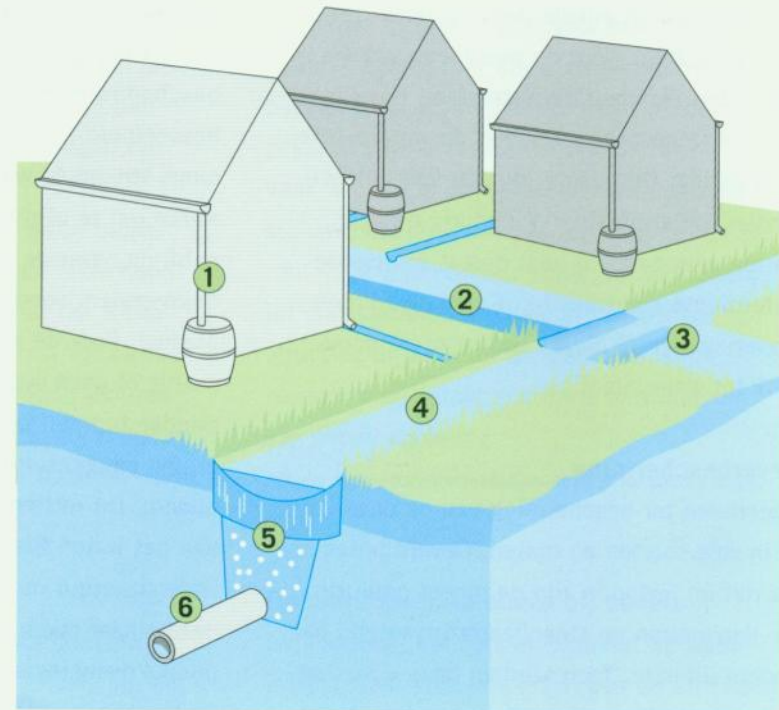

WADI: a natural regulation of rainwater

Enschede (NL): eco quarters

Oikos and Ruwenbosch



Enschede (NL): eco quarters *Oikos and Ruwenbosch*



'SLOKOP'



The 'slokop' is connected with the sewage system and prevents flooding.

THE INFILTRATION MODEL is a guideline for residential areas. Do not discharge rainwater in sewage systems. The aim is **retention** and **infiltration** of clear rainwater in urban areas. This is also important for the creation of wet conditions for plants and animals, while the groundwater level in urban areas often is very low.

Infiltratiemodel

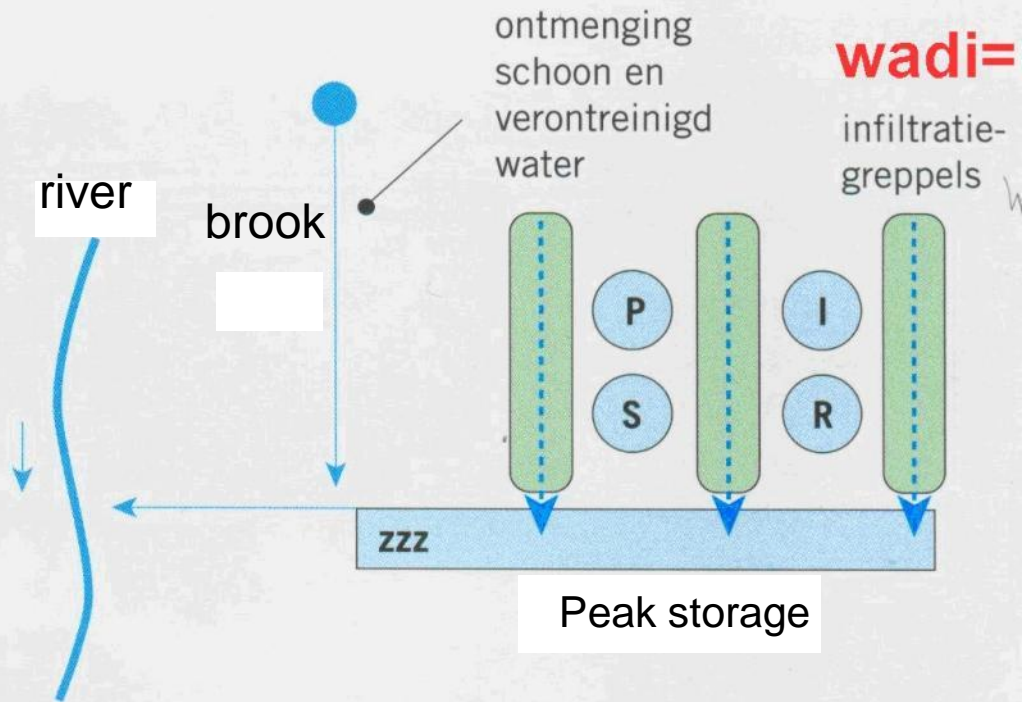
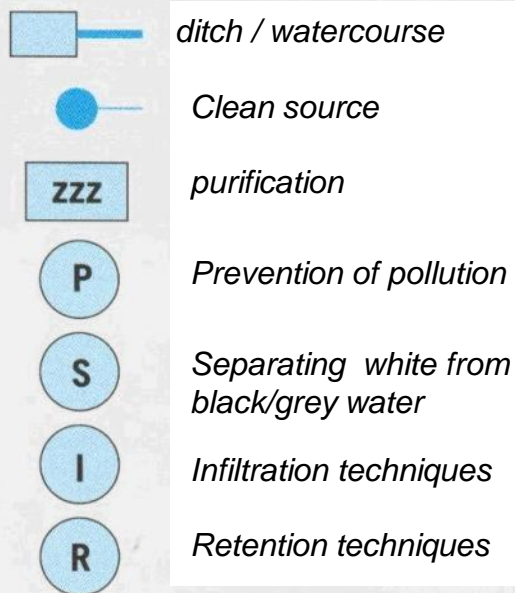

Wadi's in the eco quarters !



Culemborg (NL)



Malmö (S)

Malmö (Sweden): ecoquarter *Västra Hamnen* (western Harbour)



Germany: Ruhr area

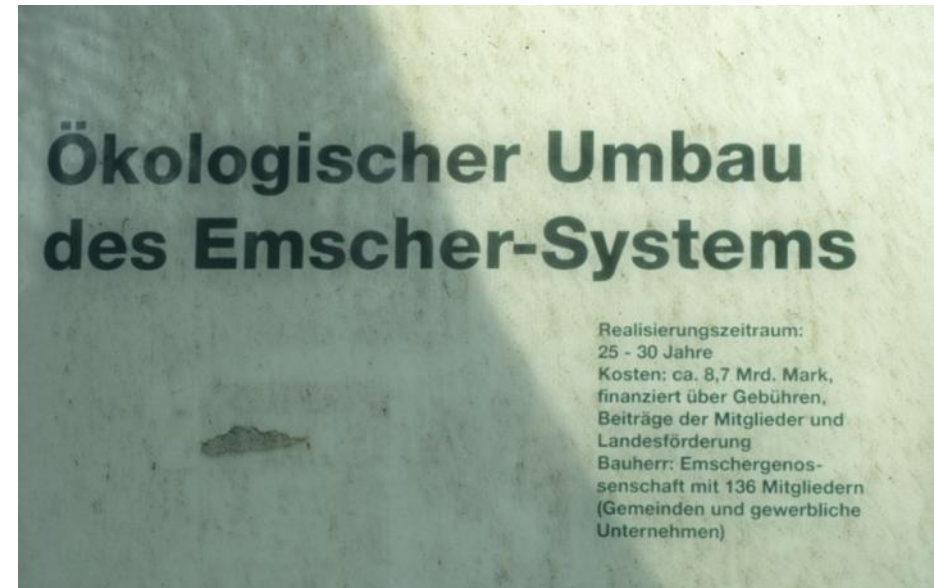

Before and...

...after 're-naturierung'

Structure of this presentation.

- 1. The cooling effect of the vegetation.
 - 2. Some climatological backgrounds.
 - 3. Climate-proof architecture, city expansion and urban planning.
 - building level
 - district (city quarter) level
 - city level
-

On the city level, the lobe city is a very good model for combining it with ecologically sound water management.

In the blue-green fingers, storm water can be stored and infiltrated, which is preventing flooding of the built-up city lobes, and is cooling the cities down

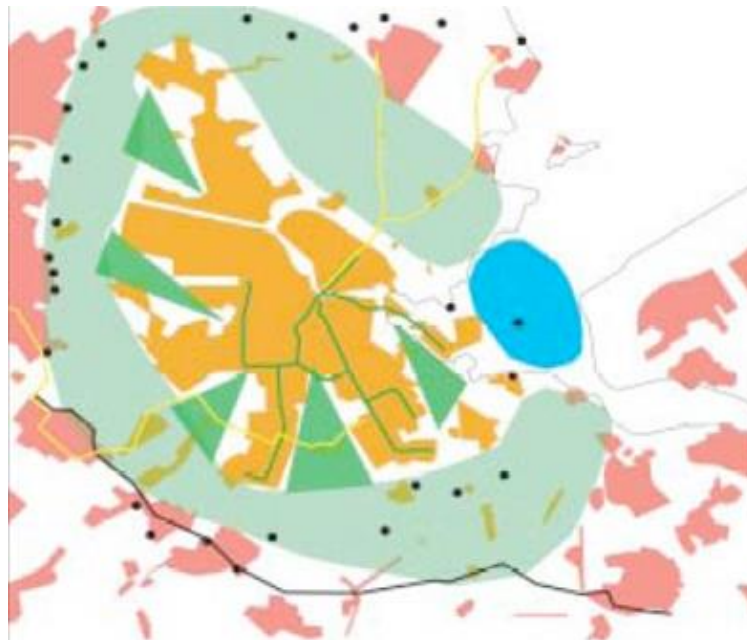

Amsterdam as a lobe-city (From Gieling, 2006)

The lobe-city model.

Compact high-dynamic
city lobes

(fast lane)

Separated from each
other by

Low-dynamic blue-
green fingers

(slow lane)

From Tjallingii, 1996

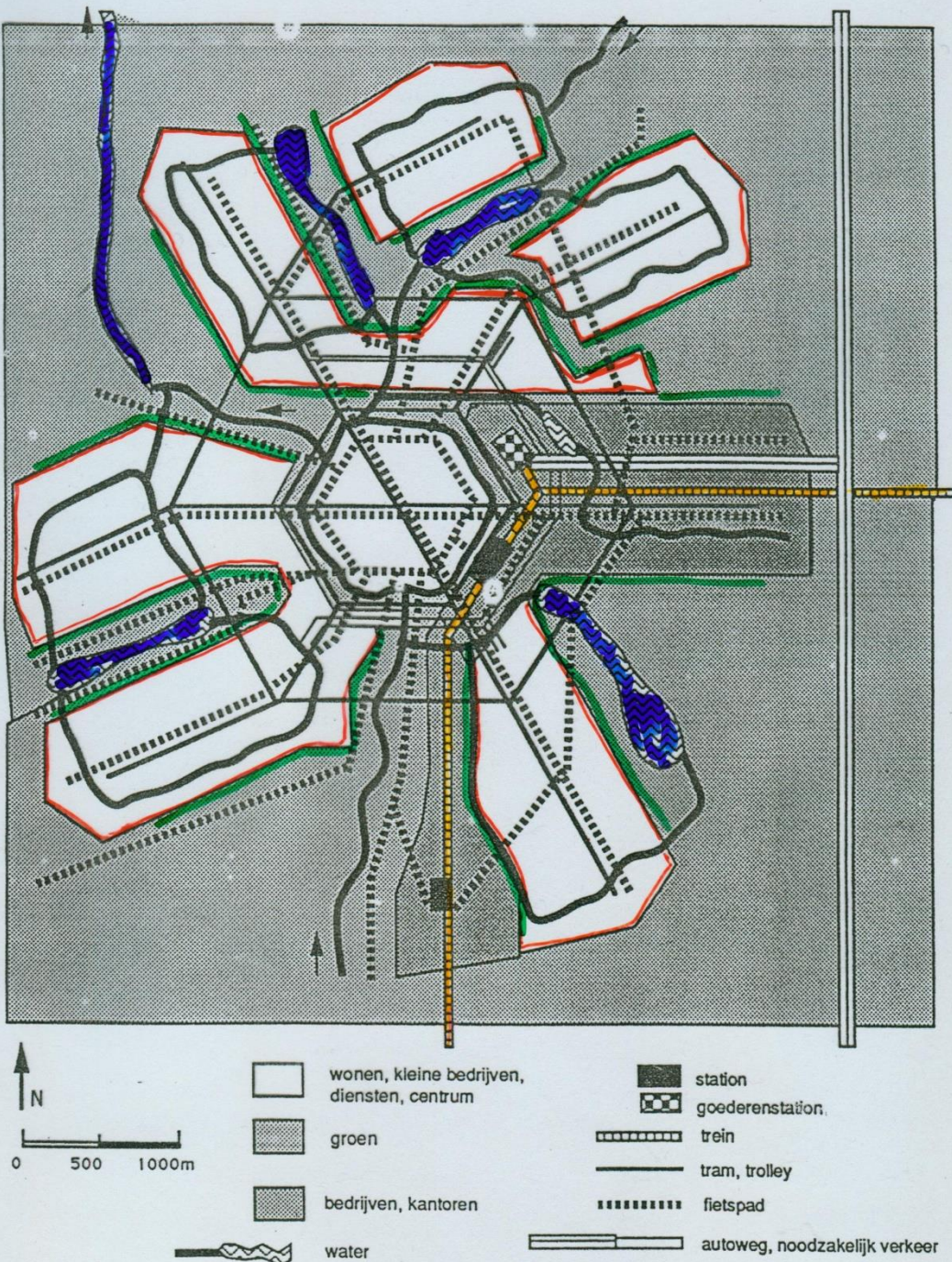

In lobe-cities the blue-green fingers are penetrating deep into the centre.

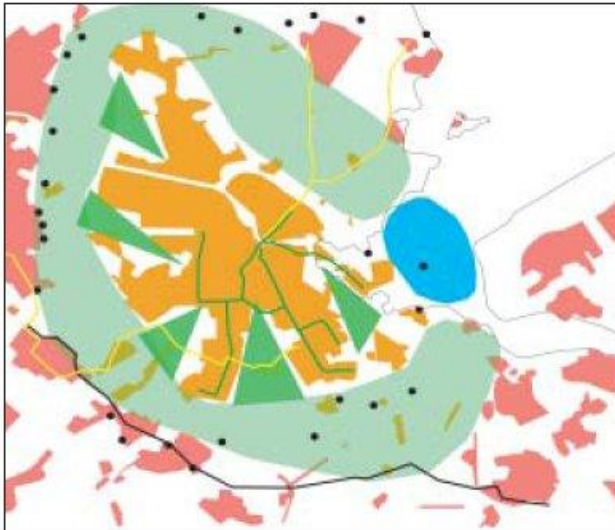

De Amsterdamse lobbenstad ligt een
zone. Daaromheen ontstaat langzamer-
en krans met bebouwing, een
amde kranstad.
Amsterdam 'finger city' is surrounded by
belt. A garland of construction is
ly appearing around it, a so-called
city.

Amsterdam (750,000 inhabitants ;
The Netherlands). From Gieling, 2006



The lobe-city model

- The lobe-city model was developed in the first half of the 20th century.
 - To varying degrees, this model was used in Denmark for the “fingerplan” in Copenhagen (Denmark) (1948), the general plan to extend Amsterdam (The Netherlands) (1935) and in cities such as Hamburg, Köln (1927), Berlin, Stuttgart (Germany) and Stockholm (Sweden).
 - Also the planners developing Shanghai Dongtan (China) as an eco-city, use the concept of blue-green fingers.
-

The blue-green fingers are tempering the heat island effect in Berlin (3,400,000 inh. ; Germany)

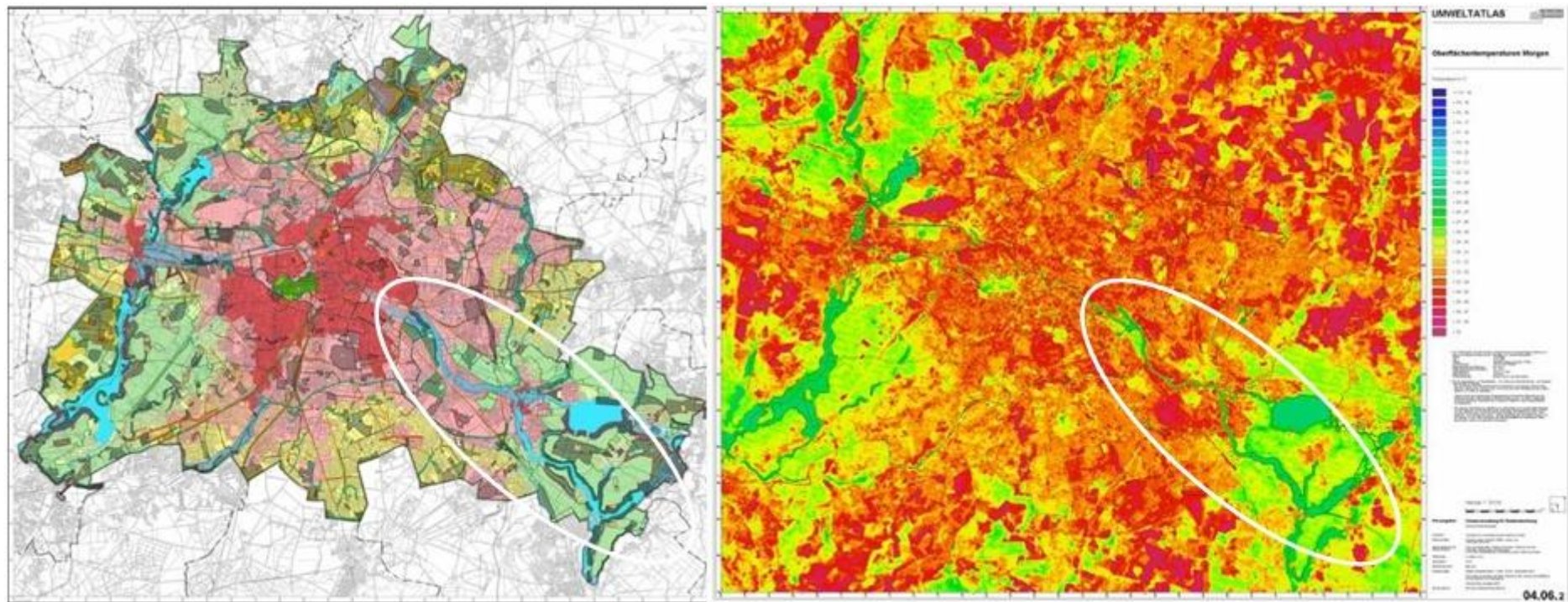

Infrared picture of hot city-lobes and cooler blue-green fingers of Berlin. (Cloos, 2006)

Urban blue-green fingers as a cooling infrastructure.

4 ecosystem services of blue-green networks

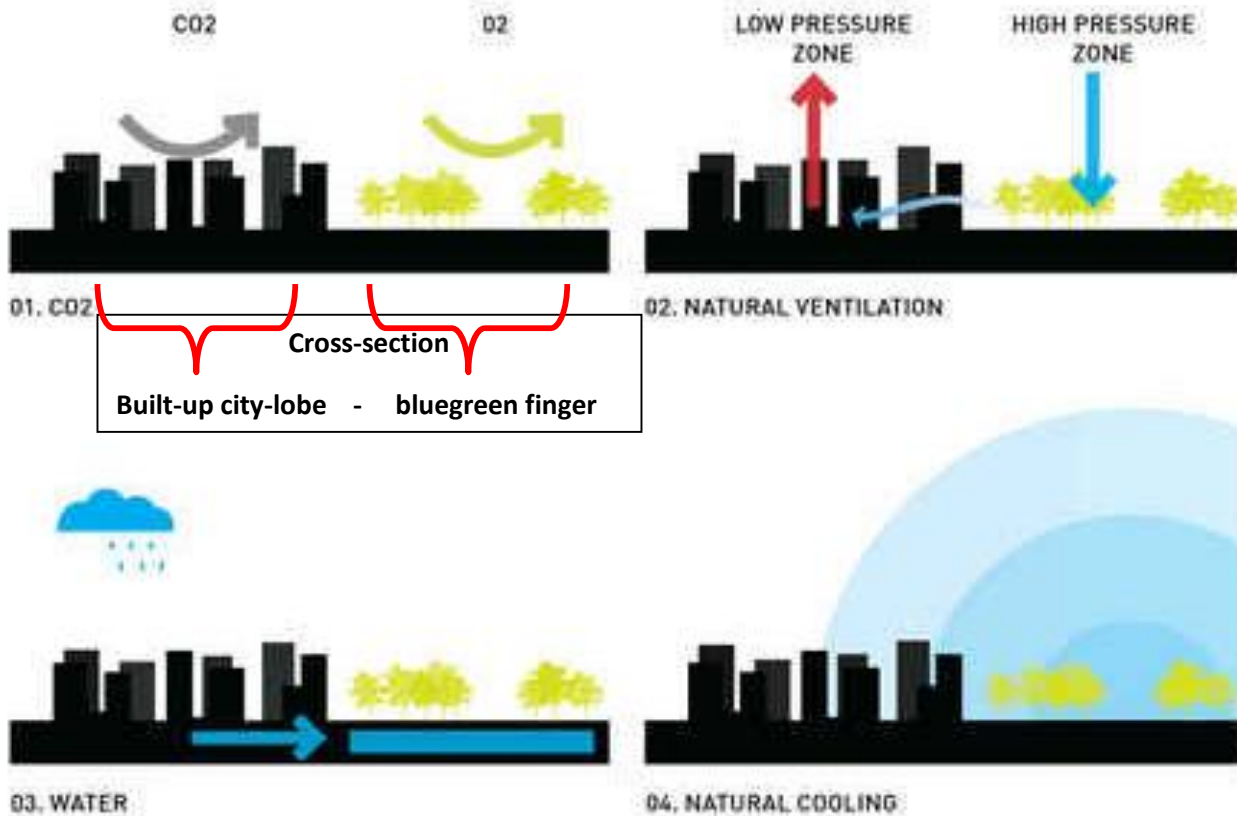

► Rond de Amsterdamse lobbenstad ligt een groenzone. Daarmee ontstaat langzamerhand een krans met bebouwing, een zogenaamde kranstad. The Amsterdam 'finger city' is surrounded by a green belt. A garland of construction is gradually appearing around it, a so-called garden city.

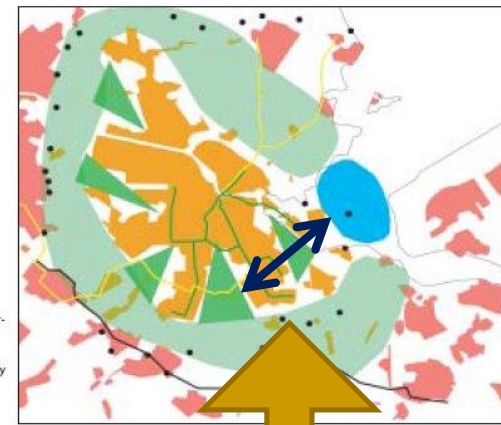

Cross-section of a lobe-city

- Calculated for the city of Valencia (Spain):

Decreasing temperature by	1°C: need for 10 ha green
	2°C: 50 ha green
	3°C: 200 ha green



Abb. 6-21: Temperaturdifferenzen (Δt) verschiedener Berliner Grünanlagen zu ihrer Umgebung in Abhängigkeit von ihrer Größe in einer mäßig austauscharmen Strahlungsnacht (9.07. 1982, 23.00 h MEZ) bei NE- bis E-Wind (nach v. Stülpnagel 1987).

Tiergartenpark (Berlin), surface 210 ha.

<http://www.stadtentwicklung.berlin.de/umwelt/stadtgruen>

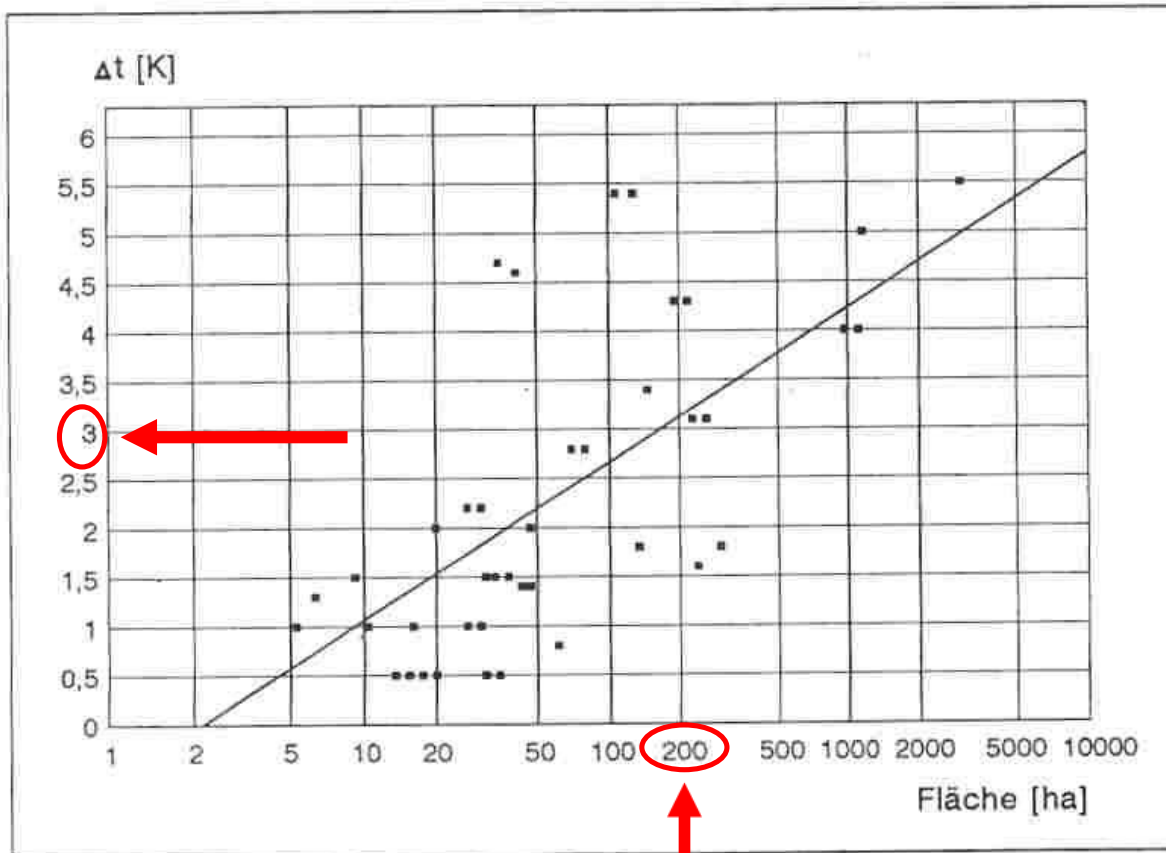

Influence of the Tiergartenpark (Berlin) on temperature

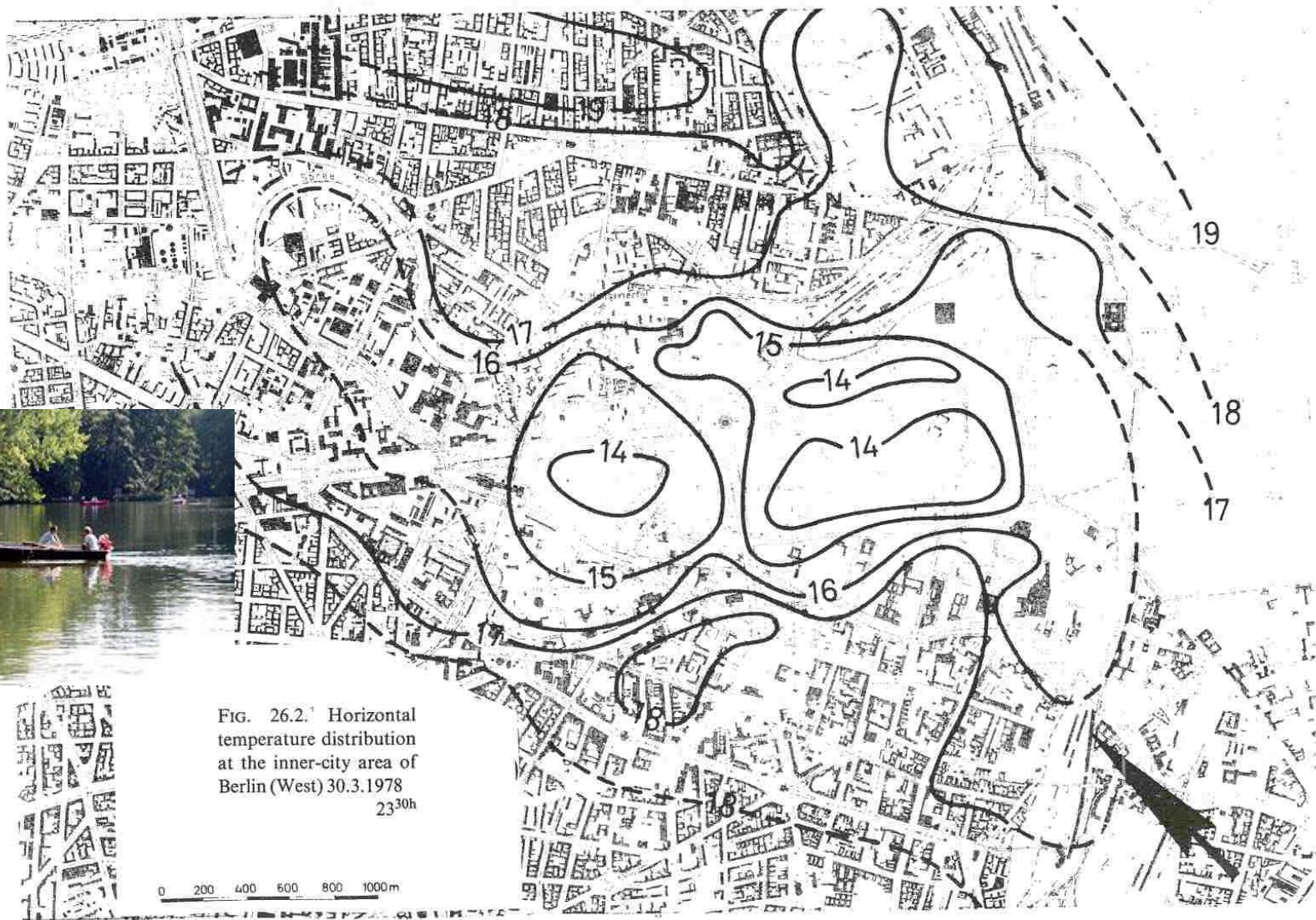

Influence of the Tiergartenpark (Berlin) on humidity

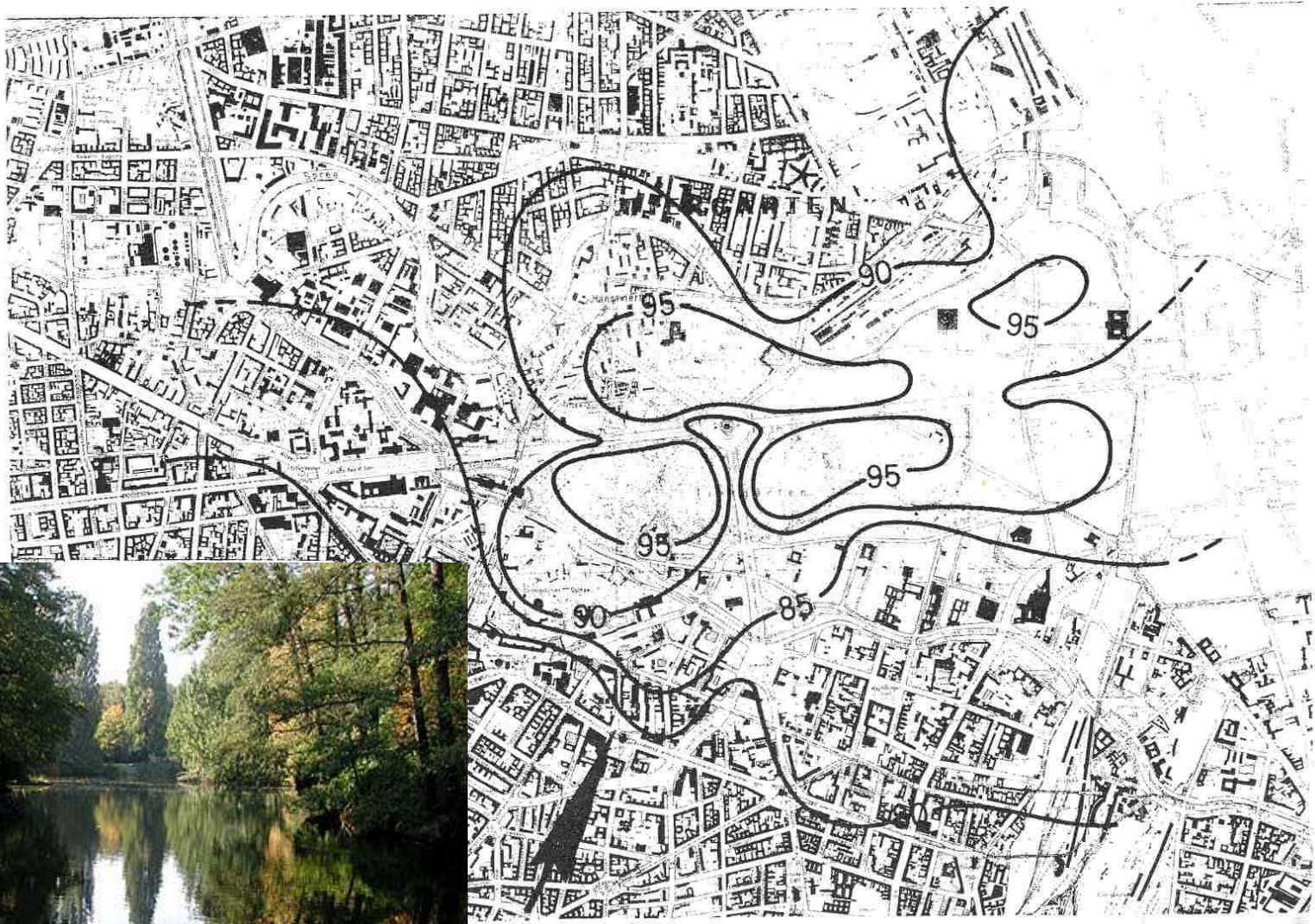

De Blust, 2006.

City climatic influence of the Tiergartenpark (Berlin)

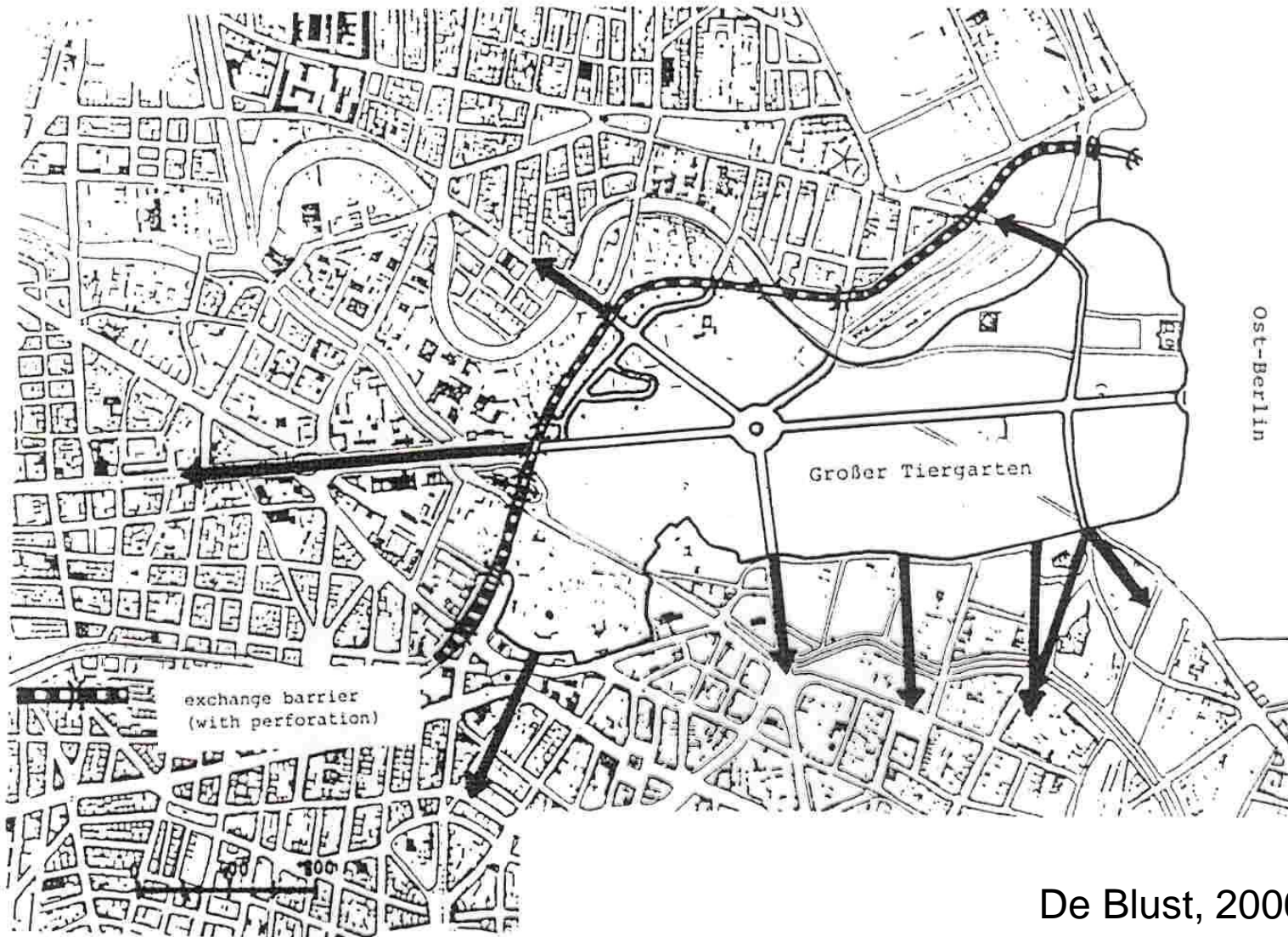

De Blust, 2006.

Fig. 7. Maximum ranges of climatic influence (length of arrow) from the 'Tiergarten Park', measured for air temperature at 2 m (from von Stülpnagel, 1987).

Densely built-up city-lobes, separated from each other by vast blue-green fingers (City of Tübingen ; 85,000 inh. ; Germany)



In the city-lobe *French Quarter* live 240 inhabitants/ha and 50 à 60 labour places / ha are created.

Mixing of functions was required !



The lobe-city of Houten (NL)

- This municipality is world known for the sake of **bicycle-based city building**, in the context of a lobe-city.
- Each residential district is accessible via a loop by car from city ring. If you want to drive by car from one district to another, you have to drive back to the city ring.
- For cyclists and walkers, all districts are interlinked strongly.



The lobe-city of Houten (NL)

- **Urban blue-green network is separating city districts from each other for cars.**
- For cyclists and walkers, all districts are interlinked strongly.

Residential city quarters of the municipality Houten (NL) are quite well interlinked for bikers and pedestrians.



Within the blue-green fingers, a lot of (low-dynamic) functions can be combined: city-farms and children-farms, cemeteries, outdoor sports infrastructure, historic fortifications, city parks, etc.



The finger plan of Copenhagen (DK)



Finger Plan (Local Plan Office for Greater Copenhagen, 1947)

http://www.pashmina-project.eu/doc/PASHMINA_D2.3.pdf

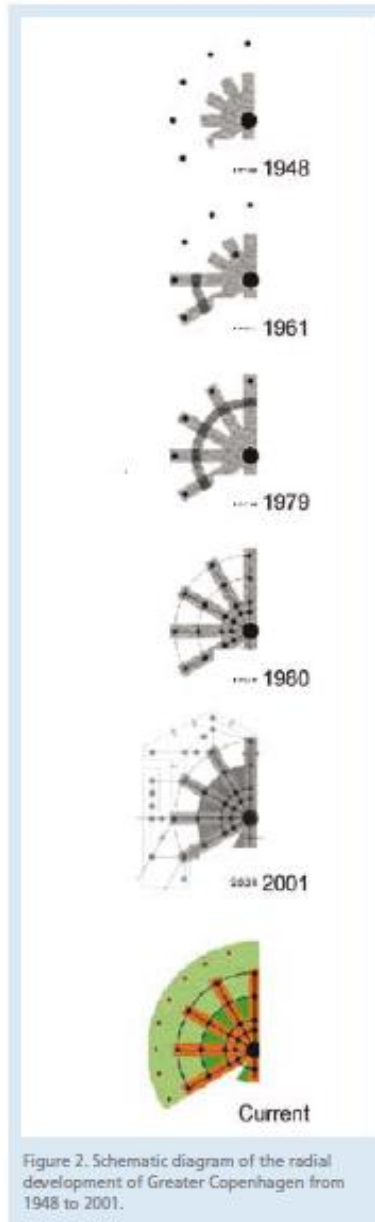

Figure 2. Schematic diagram of the radial development of Greater Copenhagen from 1948 to 2001.

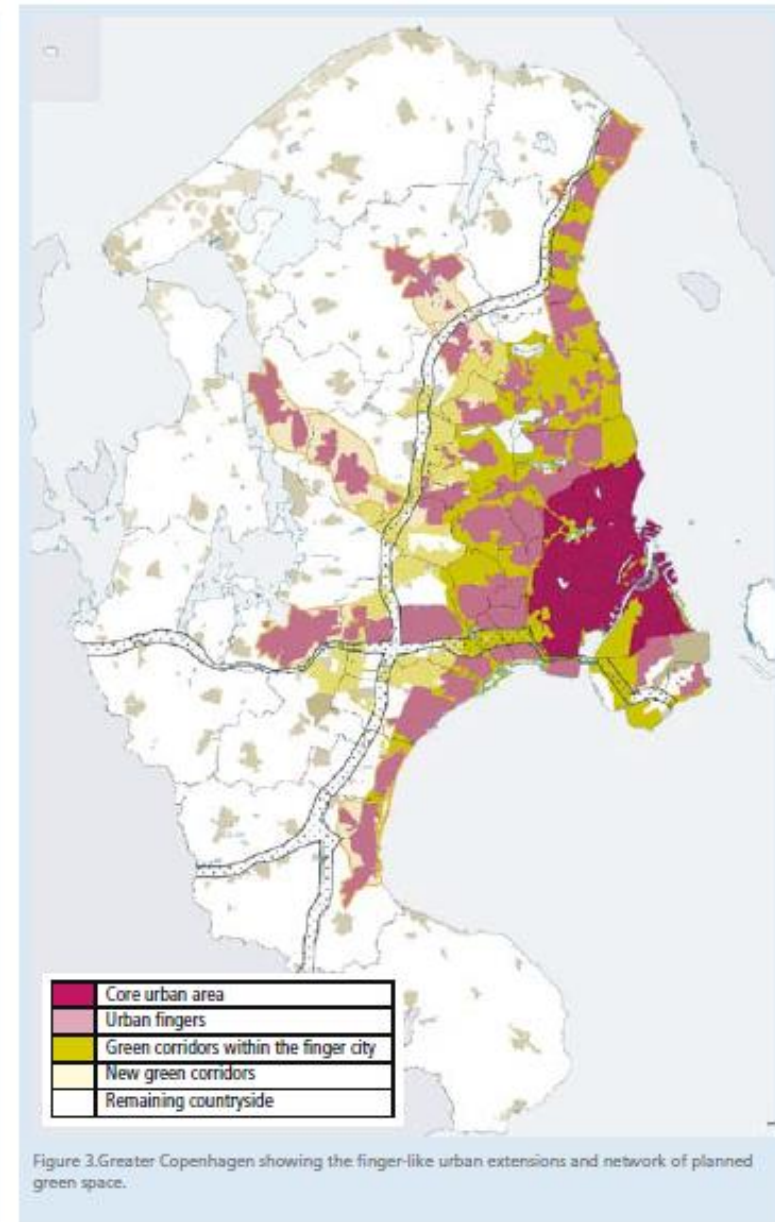

Figure 3. Greater Copenhagen showing the finger-like urban extensions and network of planned green space.

The Finger Plan includes not only the relatively small Municipality of Copenhagen covering the centre part of the city with app. 0.5 mill citizens but in addition take in the Greater Copenhagen Area, and thus also covers 34 adjacent municipalities.

source: UCD, 2008.

Copenhagen (DK)



1947 and 2007 Finger Plans

Historically, the Copenhagen suburbs have been developed according to the **Finger Plan** from 1947 which intends for the suburbs to develop as fingers along commuter rail lines separated by green wedges.

Designing a lobe-city means the designing of contrasts:
TWO NETWORK STRATEGY (S2N) .

- This is a spatial planning strategy in which the water network is carrying the blue-green fingers while the traffic network is carrying the built-up lobes.
 - So there is a need to design CONTRAST, very close to each other, because people need both: high dynamic building/industry/agriculture zones very close to low dynamic blue-water/green-nature/leisure zones.
-

Two network strategy S2N

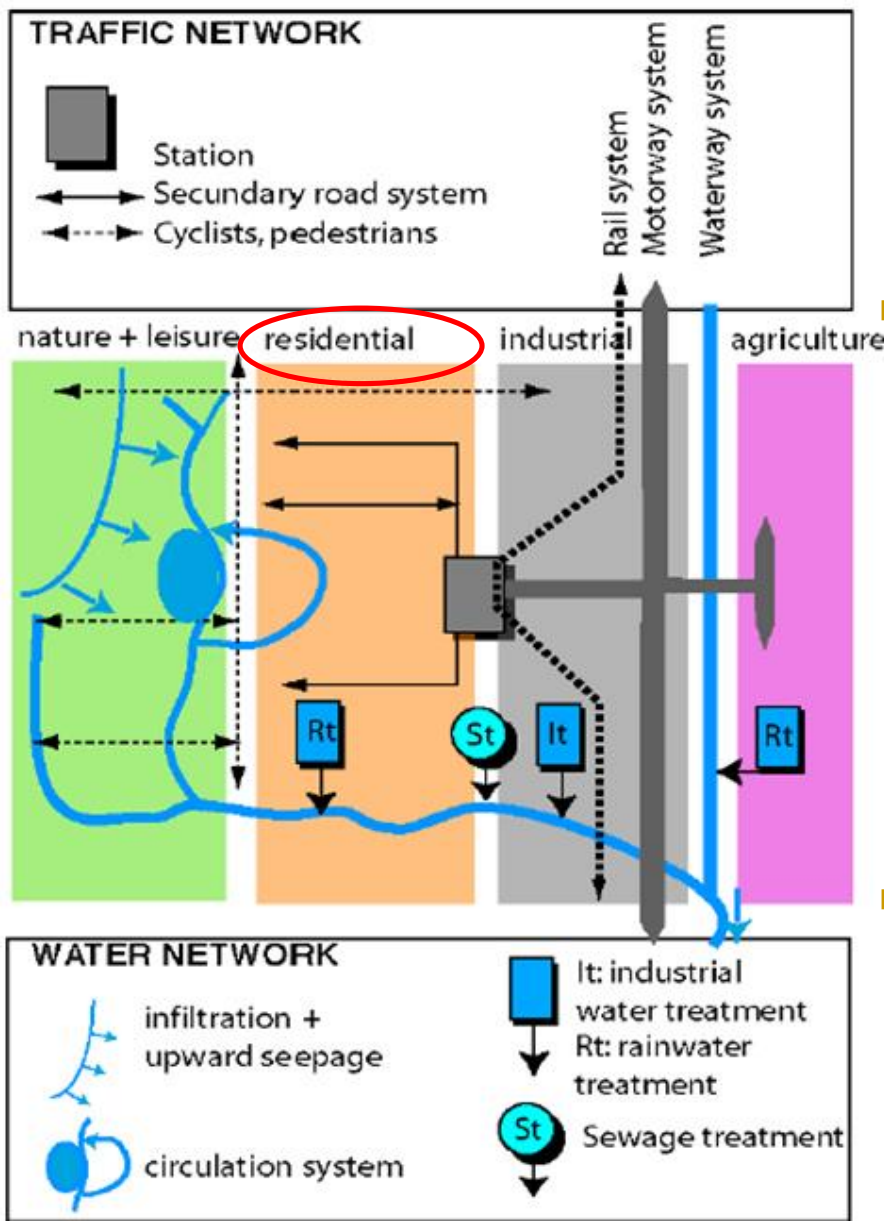

The residential areas are situated in-between the low dynamic and the high dynamic zone. The **two networks create a good position** for residential land-use in the middle, with free access to both the slow lane and the fast lane.

Notice that conventional agriculture is regarded as a highly dynamic activity, which is better linked to the industrial area rather than to the blue-green zone.

Low- —————→ High-dynamic

TWO NETWORK STRATEGY (S2N) .

- This model combines the guiding models for water and traffic flows with an ecological zoning principle : the gradient between quiet low dynamic green zones to the high-dynamic traffic zone, has to coincide with the transition between upstream clean water and more polluted water downstream.
 - Within the blue-green fingers (SLOW LANE) all the low dynamic activities are concentrated such as foot paths and cycle lanes, city farming, soft recreational forms, nature, ponds for the infiltration and retention of rain water, controlled flooding areas, cemeteries, some sports infrastructure,
 - Within the built-up city lobes (FAST LANE) all the high dynamic activities are planned, such as industrial activities, trade services, mass recreation, ...
-

Citizens' densities have to be high enough to enable affordable (light) rail public transport in the city lobes of a lobe city.

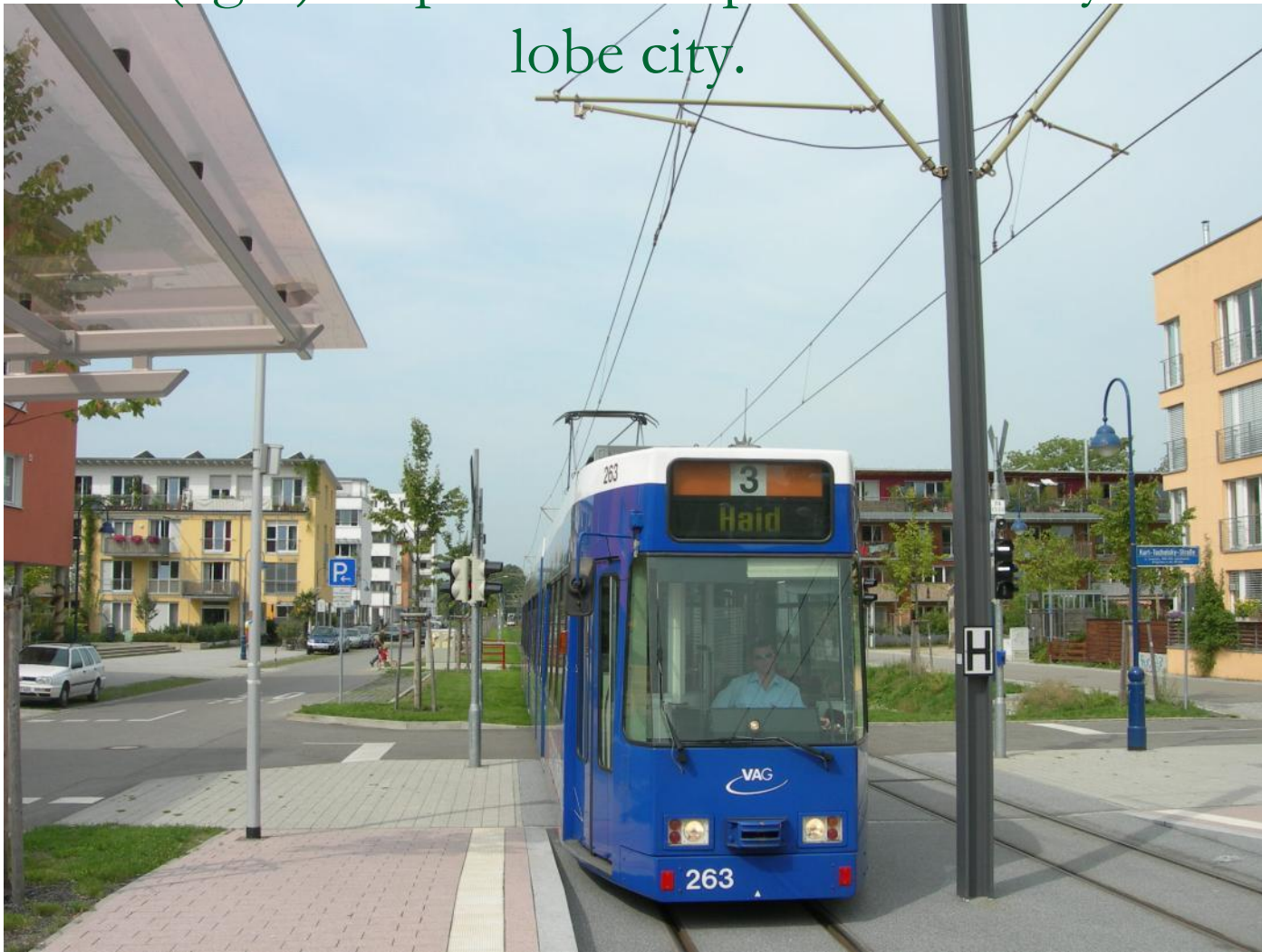

The densely populated ecoquarter 'Quartier Vauban' in Freiburg (D.) is frequently connected with the centre of the city by tram.

High densities in the eco quarter *Vauban* (Freiburg, D)



Tjallingii (1996) makes a plea for a minimum of 50 dwellings/hectare , which is far more than the 25 dwellings/ha, as obligatory in Flanders' spatial plan .

Designing a well thought **public-private gradient** in the **green areas** is a key towards higher densities.



Culemborg (NL). Ecoquarter *EVA-Lanxmeer*

Ontwerp Vasalishof





Public-private gradient in the green areas

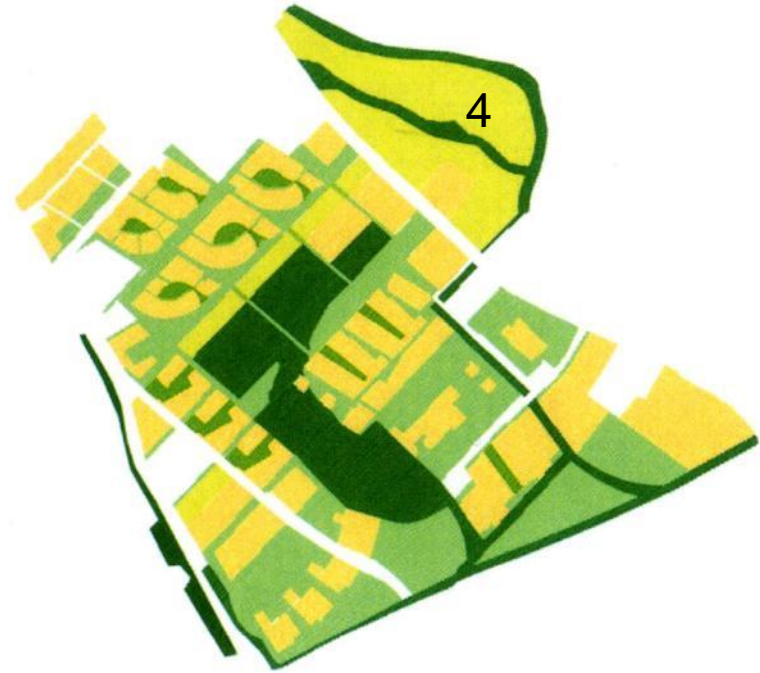

- Zone 1: Private gardens and terraces (PRIVATE)
- Zone 2: gentle gradient from private to public
(SEMI-PUBLIC / SEMI PRIVATE)
- Zone 3: intensively used public area, parks, 'edible' landscape
(PUBLIC)
- Zone 4: city farm (PUBLIC)
- Zone 5: Watershed area , natural river banks (PUBLIC)

Public-private gradient in detail

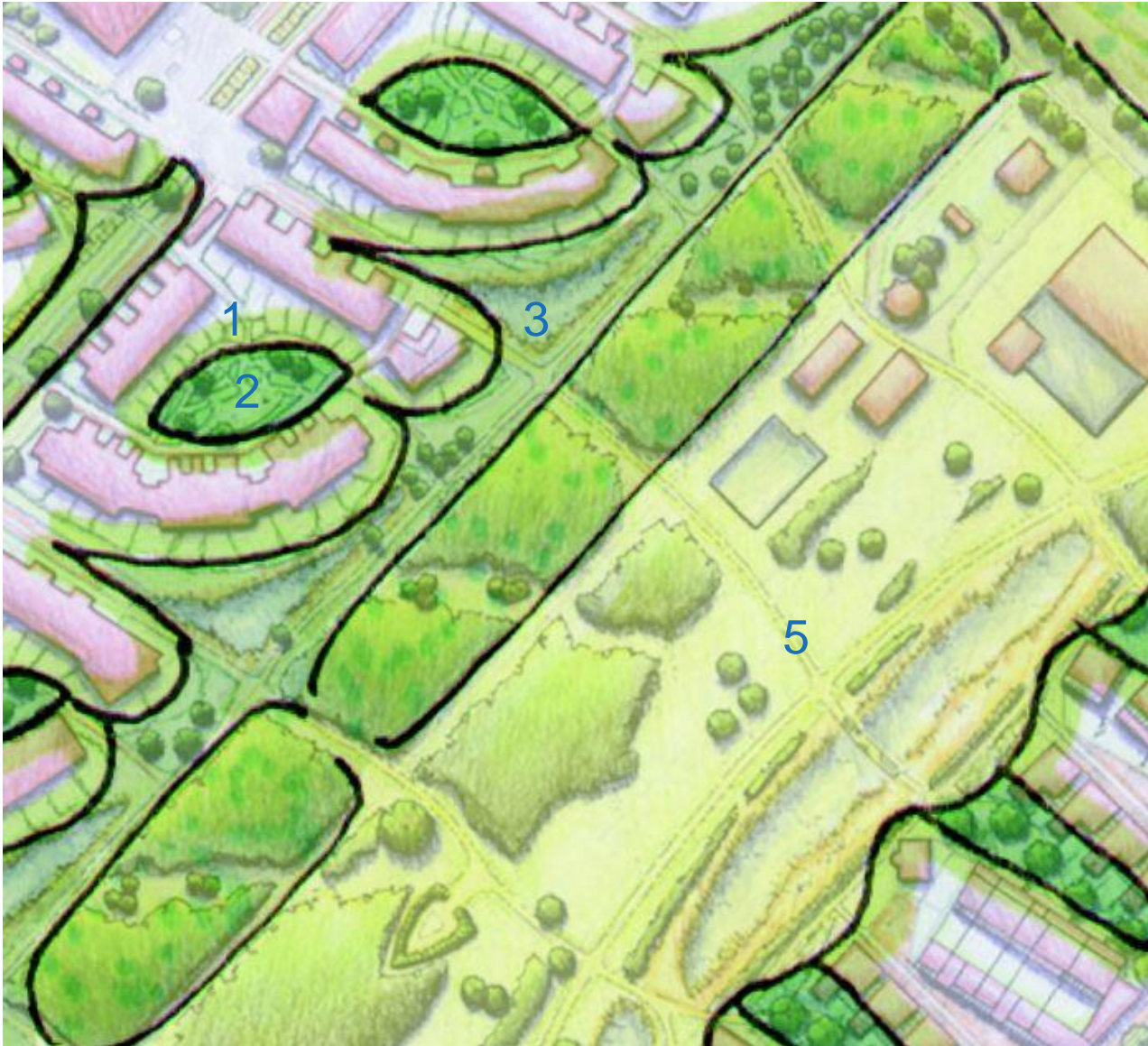

Zones in EVA-Lanxmeer:

1. Private gardens
2. Semi-public 'hof' is collectively owned
3. Public park
4. Public city farm.
5. Public green along the river.

Semi-public 'hofjes', as connecting zones, are very attractive for children.





Gentle, blurred gradient between private gardens and public green within blue-green fingers.

Very important for urban biodiversity and safe for children.





View from the living through the private garden towards the public green area.

Or how a small garden becomes large for the k

Is a well thought public-private gradient also possible in the inner cities ? Case study from the centre of Kolding (DK).



Casestudy Kolding (DK).

neplan og lokalplaner. Med denne baggrund var det naturligt for Kolding Kommune sammen med Byfornylselskabet DANMARK at udvikle og afprøve et økologisk byfornyelsesprojekt.

bl.a. lavtskylstoiletter, vandbesparende armaturer, regnvand til toilet-

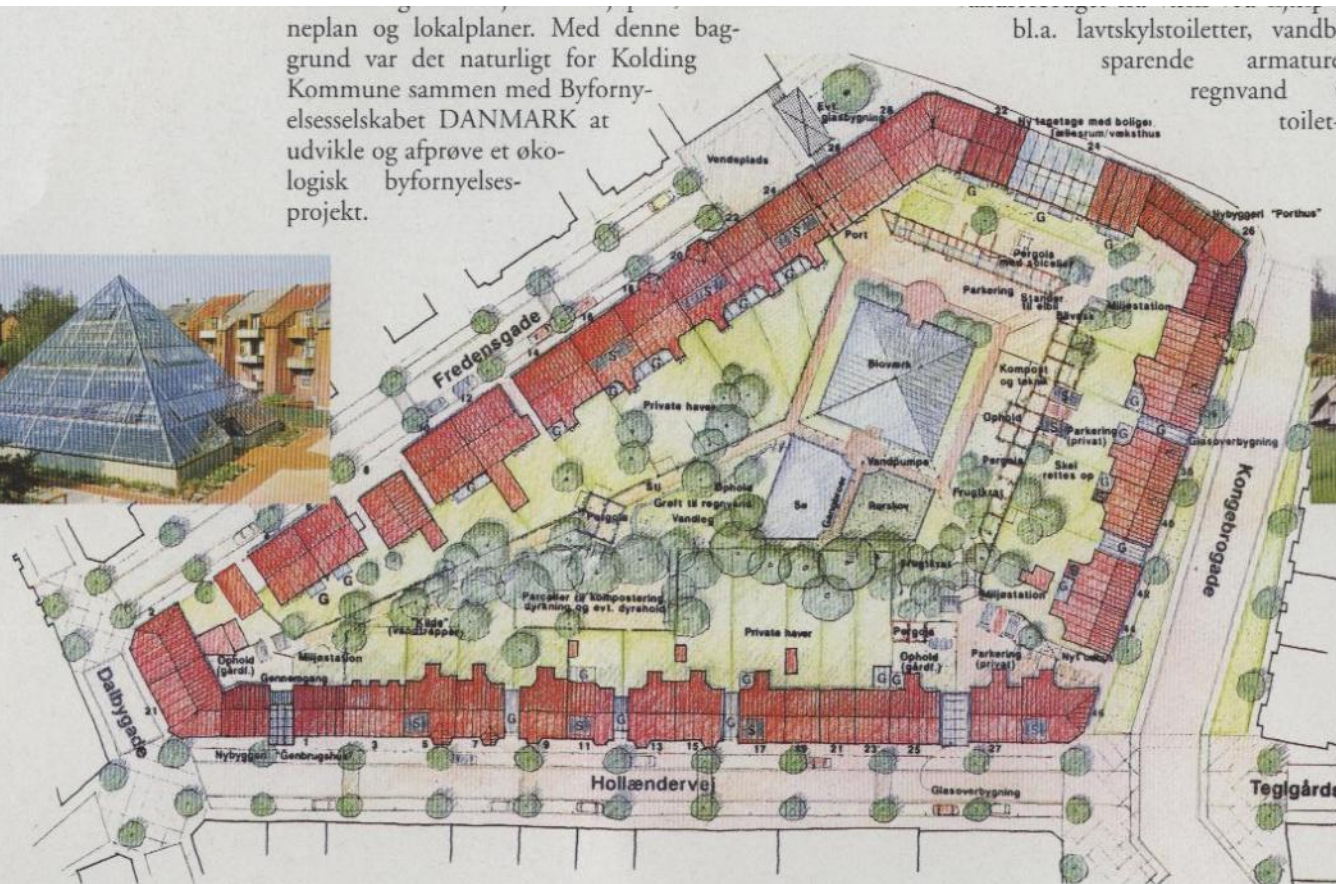





Wadi for infiltration of white water



Black and grey water are purified in a plant purification system.

Plant purification system in Kolding (DK), in a glass pyramid in the middle of the semi-public garden.



The municipality is maintaining the inner garden, in exchange for limited access for the public.

Kolding (DK)



Utrecht (NL)



Risk: privatising gardens to an ecoghetto for the 'happy few'.

Malmö (S)



Culemborg (NL)



Copenhagen (DK)

Semi-public gardens in the eco quarters Loretto-areal and Französisches Viertel (Tübingen, D)



CONCLUSION (1):

- In ecovillages, a lot of experience is gathered with the public-private gradient as well in the green areas as in and between the buildings, most of them in rural context.

<http://www.gen-europe.org>

<http://www.oekosiedlungen.de> / <https://siedlungen.eu/>

- These experiences deserve to be translated and adapted to be used within cities and villages in order to create and build ecoquarters and to provide good ideas for the transition of traditional towns and city quarters..
-

CONCLUSION (2): Towards climate-proof urban development .

Lobe-cities can **buffer** climate change (global warming and changes in precipitation) because they

- Offer **blue-green fingers** with possibilities to buffer and to infiltrate rainwater, avoiding flooding downstream of the city. An ecologically sound green management of those blue-green wedges can improve and restore urban biodiversity.
 - Temper the urban heat island effect, because the **blue-green fingers** stimulate urban ventilation, based on convection.
-

CONCLUSION (3): Towards climate-proof urban development .

Lobe-cities can help to **avoid** further climate changes because they:

- Show enough compactness within the built-up **city-lobes**, which therefore can be carried easily by central public (lightrail) transport axes.
 - Provide densely built-up **city-lobes** which can be heated easily with small and local CHP plants, connected to a district heating system, so carbon emissions can be decreased strongly.
-

Sustainable urban planning.



ROMBAUT, E. & E. HEUTS. 2010. *‘Duurzame Stedenbouw’ in woord en beeld. Gids met praktijkvoorbeelden voor de transitie naar een ecopolis.* Boek samengesteld voor VIBE vzw en ABLLO vzw (i.s.m. KaHo Sint-Lieven dep. Sint-Niklaas en het departement voor architectuur en stedenbouw Sint-Lucas Gent/Brussel). Uitgeverij Die Keure 164 pp. ill. D/2010/0147/260 ; ISBN 978 90 4860 734 1.

http://www.abllo.be/sites/default/files/ECOPOLIS_160101/11_Publicaties_en_artikels/2010_Duurzame_Stedenbouw_in_woord_en_beeld_Erik_ROMBAUT.pdf

Thanks for your attention!

Culemborg (NL)
Ecowijk
EVALanxmeer

